

FREE STYLE

CAMERETTE + ZONA STUDIO

Progetti in evoluzione **GLOBO_VEGA**

night collection

uniscono
elementi di
design
in composizioni
giovani nuove
e dinamiche

SPAGNOLmobili

concept
free
Style

PER UNA CAMERETTA
IN CRESCITA

PROGRAMMA GLOBO - VEGA

—
Una camera che cresce con te, un progetto in continua evoluzione,
nato integrando elementi funzionali di design in composizioni che
si evolvono al cambiare delle esigenze.

—
A room that grows up
with you, an evolving
project, created
integrating functional
elements of design
in compositions
that evolve with the
changing needs.

SPAGNOLmobili

I PROGETTI
 SPAGNOL PER
 LE CAMERE
 DEI RAGAZZI
 NASCONO DA
 UNA CONTINUA
 RICERCA SUI
 MATERIALI,
 LE SOLUZIONI
 TECNICHE E LA
 SICUREZZA UNITA
 ALL'INNOVAZIONE
 ESTETICA PER
 INTERPRETARE
 GLI STILI
 DELLE NUOVE
 GENERAZIONI

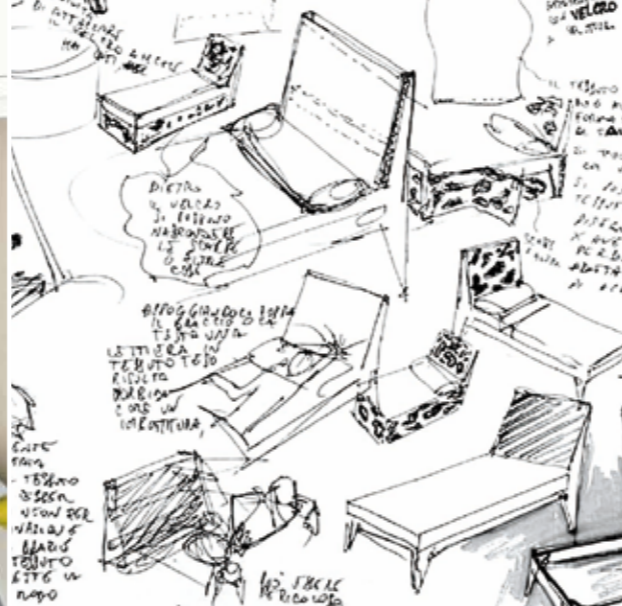

The projects Spagnol for kids' rooms are born from a continuous research on materials, technical solutions and safety combined with innovation aesthetic to interpret the styles of the new generation.

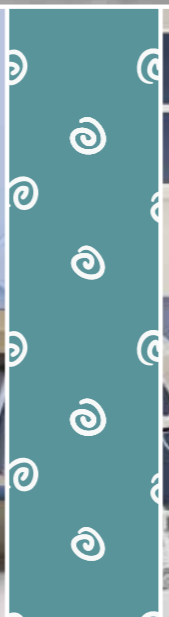

48 **Colori laccati opachi**

29 **Colori laccati lucidi**



48 mat lacquered colors, 29 glossy lacquered colors

Una grande tavolozza di colori per dare spazio alla fantasia e alle emozioni con le tinte più moderne, allegre e vivaci oppure serene e rilassanti.

A large palette of colors to give space to the imagination and emotions with the most modern colors, cheerful and lively or serene and relaxing.

6 **Finiture nobilitato per le strutture**

16 **Finiture nobilitato per frontali Spazio**

6 melamine finishes for structure

16 melamine finishes for Spazio doors

Il calore del legno in diverse sfumature per ambienti luminosi o con un tocco classico. Un materiale resistente per dare sicurezza, praticità e stile.

The warmth of wood in different shades for bright rooms or with a classic touch. A durable material to give security, convenience and style



100% **Tessuti in cotone anallergici**

100% hypoallergenic cotton fabrics

La morbidezza delle trame di cotone e la bellezza naturale dei colori. I tessuti creano un'atmosfera piacevole, accogliente e soprattutto di alta qualità.

The softness of the textures of cotton and the natural beauty of the colors. The fabrics create a pleasant atmosphere, friendly and above all of high quality

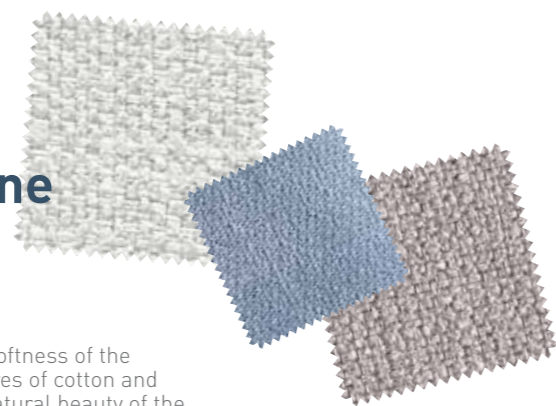

LIBERA
LA TUA
CREATIVITÀ
CON LE
COMBINAZIONI
DI COLORI
E MATERIALI

Set free your creativity with the combination of colors and materials

Musik



08

programma

GLOBO_VEGA

CAMERETTE E ZONA STUDIO
BEDROOMS AND A STUDY

—
More freedom to furnish, explore and experience, more versatility to add and recombine room elements. Space to grow and study, store and have fun, rest and invent. Is a collection made to measure for you.

PIÙ LIBERTÀ PER
ARREDARE,
ESPLORARE
E SPERIMENTARE,
PIÙ VERSATILITÀ
PER AGGIUNGERE
E RICOMBINARE
GLI ELEMENTI
DELLA CAMERA.
È LO SPAZIO PER
CRESCERE
E STUDIARE,
CUSTODIRE
E DIVERTIRSI,
RIPOSARSI E
INVENTARE.
È UNA COLLEZIONE
SU MISURA PER TE

301

Composizione
Composition





Il nuovo look della camera: funzionalità, colori e stile con eleganza giovane

The new look of the room: functionality, Color and style with young elegance

La nuova colonna a giorno sottoponte e la scrivania creano l'area studio con alti spessori, spazi diversificati e un tono originale di colore.

The new column under-bridge open and the desk create the study area with high thickness, diversified spaces and an original tone of color.



Colonna a giorno sottoponte

Under-bridge open column

L 30-46,8-61,8-91,8-121,8 x P 34 x H 132,5 cm

Le colonne a giorno sottoponte possono essere attrezzate con ante e cassetti della linea VEGA.
Can be equipped with doors and drawers of VEGA line.

Finiture disponibili: nobilitati bianco / madreperla / olmo bianco / canapa / urbano / montego e tutti i colori laccati opachi, lucidi e metal
Available finishes: melamine bianco / madreperla / olmo bianco / canapa / urbano / montego and all the matt, gloss and metal lacquered colors

Elementi ponte con attaccaglia
Bridge elements with hanger

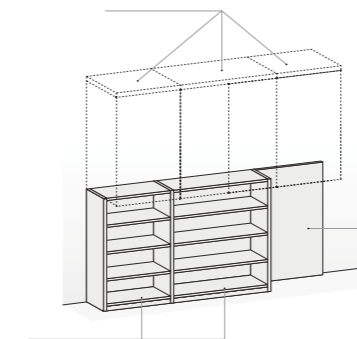

Eventuale pannello al mq (sp. 1,8 cm H 132,5 cm) con ferramenta Easy uso schienale
Possible panel per sqm (thickness 1.8 cm H 132.5 cm) with ironmongery Easy for the back use

Colonna giorno sottoponte H cm 132,5
Column day under bridge H 132,5 cm

301

Composizione
Composition



Bianco Ruggine Olmo urbano C248

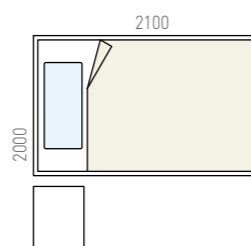
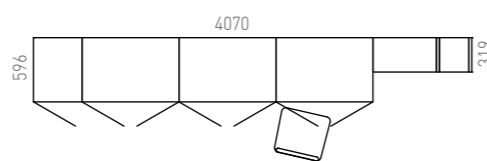

Colonna a giorno sottoponte

302

Composizione
Composition





Vasta scelta di sedie

Great choice of chairs

Le sedie possono essere scelte in base alla forma, ai materiali ed ai colori, in piu' varianti creative che rispecchiano la tua personalita'.
The chairs can be chosen according to the shape, materials and colors, creative variations that reflect your personality.



JENNY
con gambe



JENNY
con ruote



JENNY imbottita
con gambe



JENNY imbottita
con ruote



SIRIO



QUADRO ASOLA



QUADRO ROTONDO



FIORE



CUORE



OLA

Inventare nuove librerie

Inventing new libraries

E dare più dinamismo alla camera con aree integrate o separate, con ripiani e contenitori e un uso vivace del colore.
And give more dynamism to the room with integrated or separated areas, with shelves and cabinets with a vivid use of color.

302

Composizione
Composition

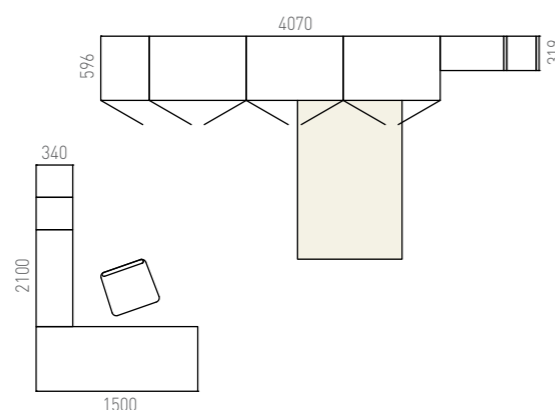
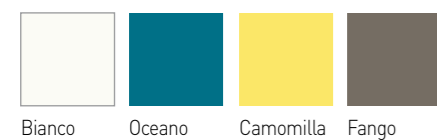

Pensili 1.2
componibili

Sedia
Quadro Rotondo

303

Composizione
Composition





Strutture dinamiche per organizzare lo spazio: l'arredo libera la tua inesauribile creatività

Dynamic structures to organize the space: furniture release your inexhaustible creativity

Una camera per due dove ognuno ha il suo spazio. Oppure una stanza equamente divisa in zona riposo e studio: con la libreria passante si organizza la camera.

A room for two, where everyone has his own space. Otherwise a room equally divided in rest or study area: the open-side library organizes the room.

303

Composizione
Composition

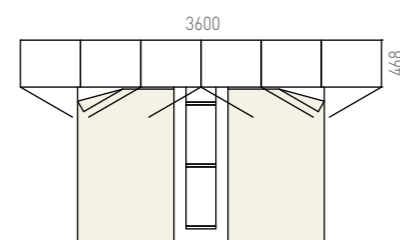
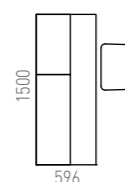
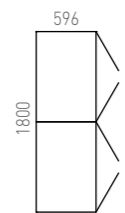

304

Composizione
composition





305

Composizione
Composition



Personalizza la cameretta, con i moduli che vuoi tu!

Customize the bedroom, with the modules that you want!

In camera vige la libertà di scelta. Ecco allora che puoi creare la tua combinazione di moduli per attrezzare la parete.

In the room there is freedom of choice. So you can create your own combination of elements to equip the wall.



305

Composizione
Composition

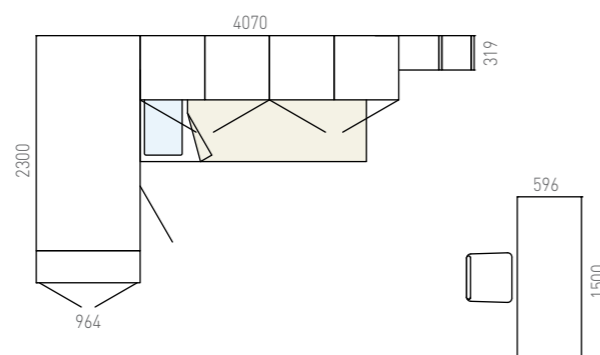
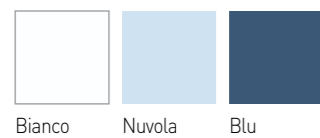

306

Composizione
Composition





Piede Quadro

Square foot

La forma è dinamica, con il lato interno obliquo. La scelta delle finiture è ricca di possibilità. Il carattere del letto nasce dal piede Quadro.

The form is dynamic, with the internal oblique side. The choice of finishes is full of possibilities. The bed's character is the square foot.

Finiture disponibili: bianco, alluminio, moka e in tutti i colori laccati opachi
Available colors: white, aluminum, moka and in all matt lacquered colors.



Le gambe del letto e gli elementi sospesi rendono la camera visivamente leggera

The legs of the bed and the suspended elements make the room visually light

Scegliere un letto con il ring arrotondato, gambe sagomate in diagonale e finiture diverse anche per la testiera e aggiungerci i contenitori sospesi: in camera c'è aria di libertà.

Choose a bed with rounded ring diagonally shaped legs and different finishes for the headboard and add the suspended elements: there is air of freedom in the room.

306

Composizione
Composition

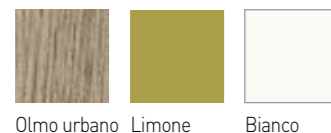

Olmo urbano Limone Bianco

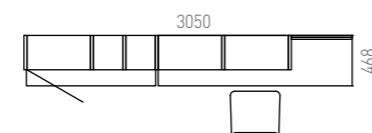
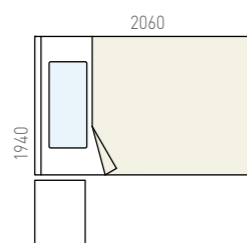
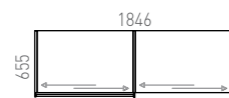

Piede Quadro



307

Composizione
Composition

Valorizzare lo spazio a disposizione con soluzioni intelligenti sempre in evoluzione

Enhance the available space with intelligent solutions constantly evolving

La scrivania è un ponte tra i vani a giorno della colonna Vega passante, i pensili 1.2 sono un po' libreria e un po' contenitori: ogni elemento dà il massimo di sé.

The desk is a bridge between the open compartments of the Vega through tall unit, the wall units 1.2 are a little library and a little cases: each element gives the best of himself.

Varianti fianco scrivania

Variations side desk



Pannello sp. 3,8 / 5,8 cm
Panel sp. 3,8 / 5,8 cm



Cono
Cone



Cilindro
Cylinder



Corner
Corner



King
King



Cavalletto
Easel



Factor
Factor

307

Composizione
Composition



Bianco Limone Antracite

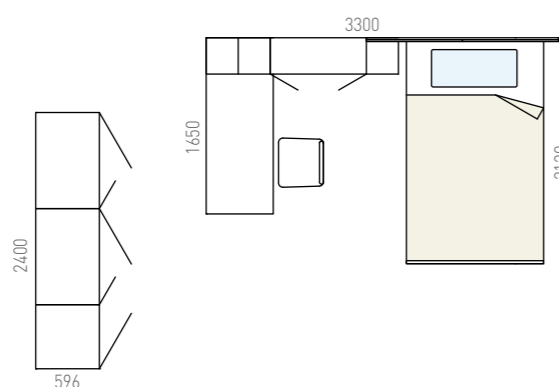

Pensili 1.2 con ante e vani a giorno



308

Composizione
Composition





Sinergia tra il programma Vega appeso e i pensili

Synergy between the Vega hanging program and wall units

La creatività diventa parete. Con le colonne sospese Vega giorno, i pensili 1.2 e gli elementi universali si realizzano soluzioni libere dove poter aggiungere sempre nuovi volumi.

Creativity becomes wall. With Vega suspended open tall units, wall units 1.2 and the universal elements create free solutions to add new volumes.

308

Composizione
Composition

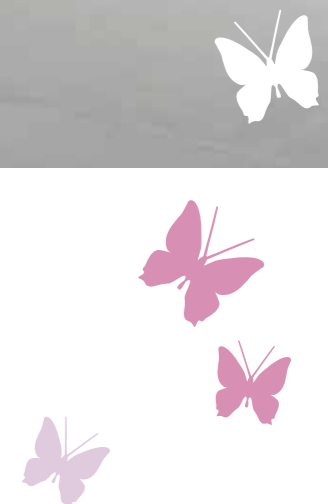
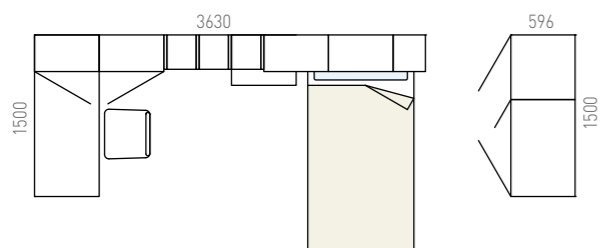
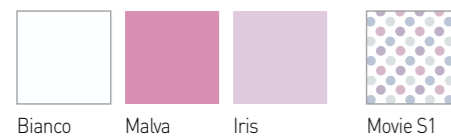

309

Composizione
Composition



La boiserie coordina un ambiente ricco di funzionalità e di gradazioni cromatiche

The boiserie coordinates a rich environment of functionality and gradations

Grande come la voglia di crescere, organizzata come un progetto per il futuro, colorata come la tua personalità.

Great as the desire to grow, organized as a project for the future, colorful as your personality.



Componibilità Boiserie Max

Modularity Boiserie Max

Modularità pannelli terminali - spessore 1,8 cm
Modularity end panels - thickness 1.8cm

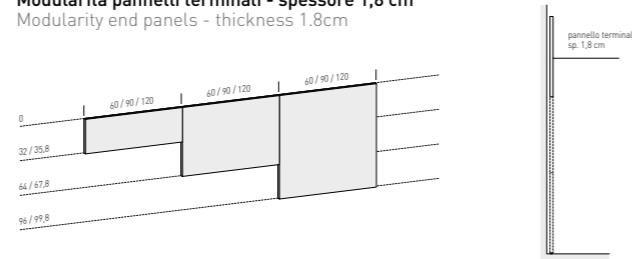

Modularità pannelli centrali o iniziali in appoggio o sospesi - spessore 1,8 cm
Modularity central panels or initials supported or suspended - 1.8 cm thick

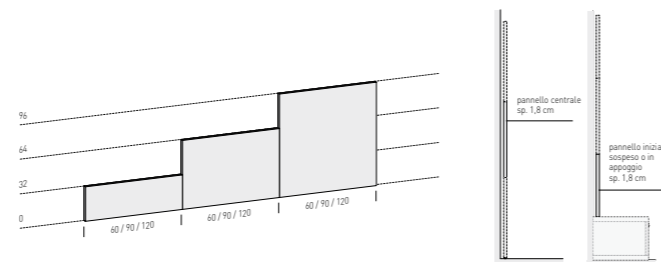

Modularità pannelli iniziali a terra - spessore 1,8 cm
Modularity initial floor panels - 1.8 cm thick

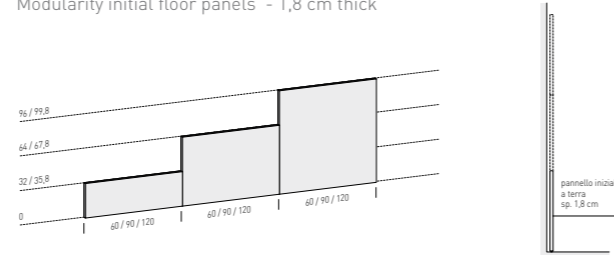

309

Composizione
Composition

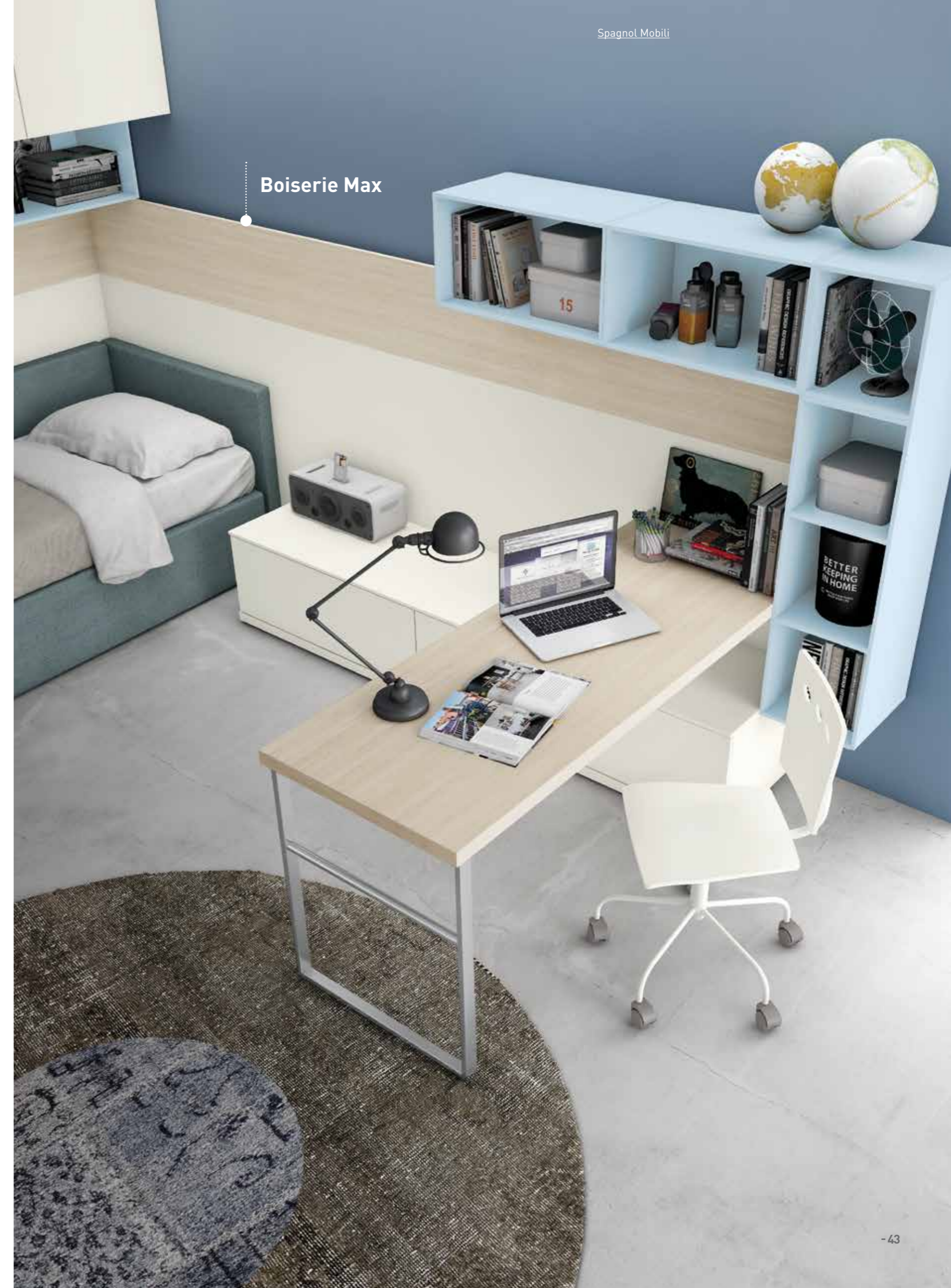
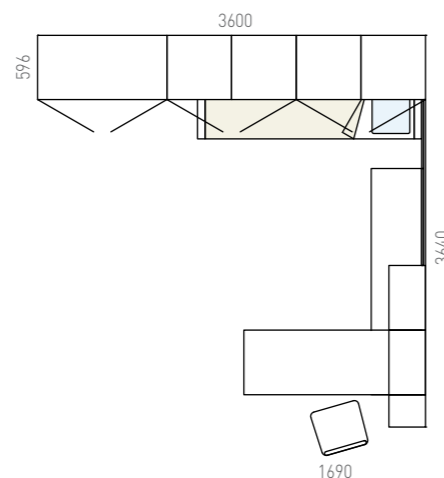
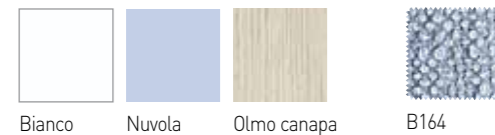

Boiserie Max

310

Composizione
Composition



B

M

S
I shot the sheriff.

THE MIND

Le tendenze del design e un raffinato uso dei colori: la camera giovane diventa glamour, per chi cerca lo stile in ogni cosa.

Design trends and a refined use of colors: the young room becomes glamor, for those who are looking for style in everything.



310

Composizione
Composition



Madreperla Blu avio

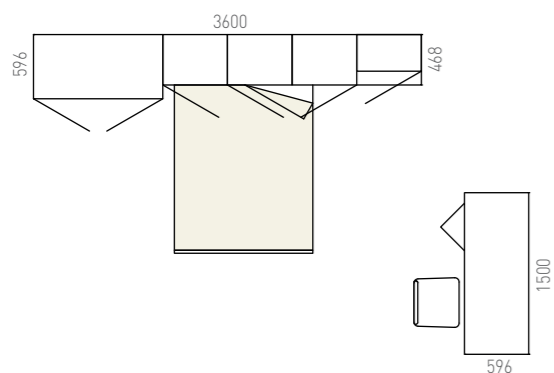

311

Composizione
Composition





Una boiserie da personalizzare, uno studio da vivere ogni giorno

Paneling from customize, a study room to live everyday

La camera diventa il tuo spazio, dove puoi appendere le tue immagini preferite, riposare, leggere e usare il computer.

The room becomes your space, where you can hang your favorite images, relax, read and use the computer.

311

Composizione
Composition



Bianco Bambù Salis C196

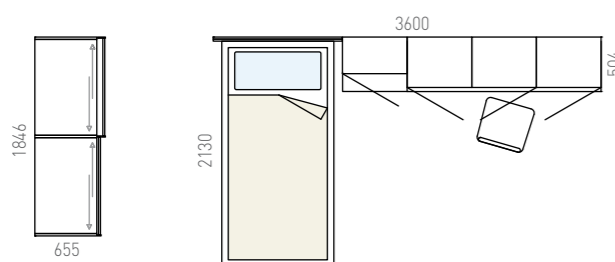

Anta Telaino T0

Door "Centrale"

L 60 / 90 / 120,2 x H 230,6 / 243,4 / 262,6 cm



Finit. pannello
Nobilitati
Nobilitati "Elite"
Laccati standard
Laccati opachi
Laccati poro aperto
Laccati lucidi
Laccati metal

Finiture profili
Finitura Alluminio
Nobilitati
Laccati standard
Laccati opachi
Laccati lucidi
Laccati metal

Finit. panel
melamine
Ennobled "Elite"
lacquered standard
matt lacquered
Lacquered open pore
glossy lacquered
lacquered metal

Finishing profiles
finish Aluminium
melamine
lacquered standard
matt lacquered
glossy lacquered
lacquered metal

I profili sono solo in verticale
The profiles are only vertically

Anta Centrale

Door "Centrale"

L 90 / 120,2 x H 230,6 / 243,4 / 262,6 cm

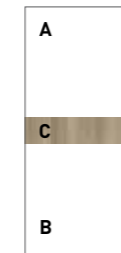

Finit. pannello A - B
Laccati standard
Laccati opachi
Laccati poro aperto

Inserto C
Nobilitati
Nobilitati "Elite"
Laccati standard
Laccati opachi
Laccati poro aperto

Finiture profili
Finitura Alluminio
Nobilitati
Laccati standard
Laccati opachi

Finishes panel A - B
Lacquered standard
Matt lacquered
Lacquered open pore

Insert C
Melamine
Melamine "Elite"
Lacquered standard
Matt lacquered
Lacquered open pore

Finishes profiles
Aluminium
Melamine
Lacquered standard
Matt lacquered

Anta Joint

Door "Joint"

L 90 / 120,2 x H 230,6 / 243,4 / 262,6 cm

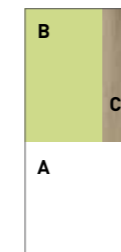

Finit. pannello A - B
Laccati standard
Laccati opachi
Laccati poro aperto

Inserto C
Nobilitati
Nobilitati "Elite"
Laccati standard
Laccati opachi
Laccati poro aperto

Finiture profili
Finitura Alluminio
Nobilitati
Laccati standard
Laccati opachi

Finishes panel A - B
Lacquered standard
Matt lacquered
Lacquered open pore

Insert C
Melamine
Melamine "Elite"
Lacquered standard
Matt lacquered
Lacquered open pore

Finishes profiles
Aluminium
Melamine
Lacquered standard
Matt lacquered



cambi di
profondità
per i pensili



312

Composizione
Composition



**Tutto in gradazione
con spazi ampi
dove muoversi in libertà
e superfici personalizzate**

All in gradation with large spaces
where moving freely and custom surfaces

Anche l'ordine può
essere creativo quando
è sapientemente
architettato. I colori
armonizzano le
funzioni con gradazioni
che allargano il senso
dello spazio.

The order can be
creative when it is
expertly architected.
The colors harmonize
the functions with
gradations that expand
the sense of space.



312

Composizione
Composition

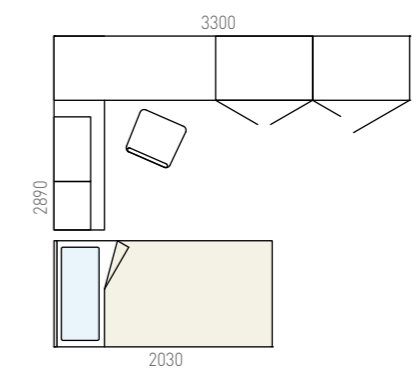
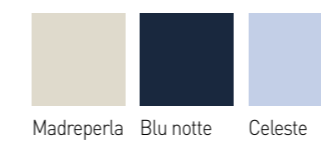

313

Composizione
Composition





*** Serigrafia Movie disponibile su ante, fianchi, pannelli boiserie e pannelli al mq**

Movie Screen Printing available on doors, sides wall panels and panels per square meter

L'anta Light si trasforma in Movie con la serigrafia delle tue immagini preferite. E il look della camera non ha più limiti.

Light door is transformed in Movie with screen printing of your favorite pictures. The look of the room has no limits.

Queste sono alcune delle texture che noi proponiamo, ma si possono serigrafare anche le vostre immagini, per personalizzare la camera.

These are some of the textures that we offer, but you can also screen print your images, to personalize the room.

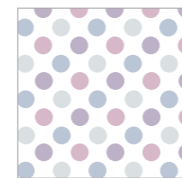
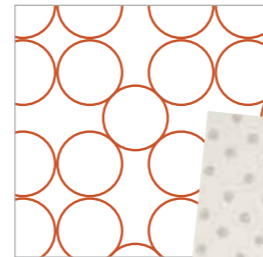

Pannelli decorativi abbinati alle essenze e ai colori: le forme diventano vivaci

Decorative panels combined with wood finishes and colors: the forms become lively

Boiserie e frontali: i pannelli personalizzati con le immagini o i motivi serigrafati che vuoi, perché lo stile non ha età.

Wall panels and door: the panels customized with images or screen-printed patterns you wish fit into the game finishes, because the style is ageless.

313

Composizione
Composition

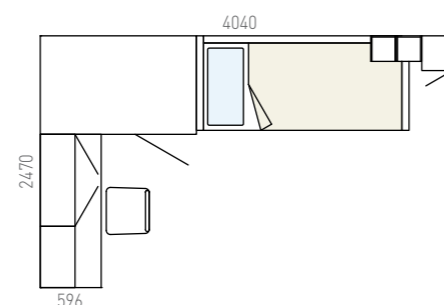

Serigrafia Movie



314

Composizione
Composition





I tuoi colori preferiti i tuoi spazi arredati con fantasia: la camera è il tuo mondo

Your favorite colors your space furnished
with imagination: the room is your world

Superfici pratiche e sicure
dove disegnare, solide
e facili da pulire. Moduli
a giorno per creare la
libreria e un pannello
decorato per coordinare il
tutto con allegria.

Practical and safe surfaces
where draw, solid and easy
to clean. Open elements
to create the library and a
decorated panel to coordinate
everything with joy.

314

Composizione
Composition

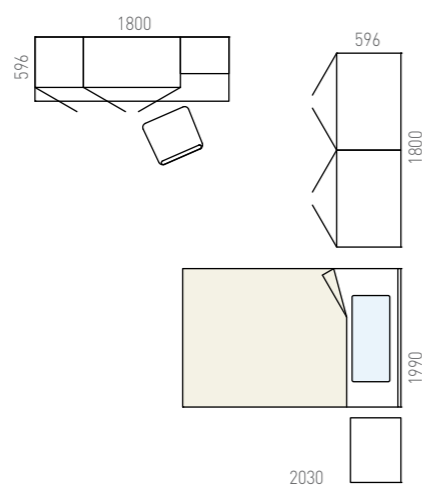

315

Composizione
Composition





Pareti e arredo si fondono in un progetto unico e personalizzato

Walls and furniture merge into a unique and custom project

Con elementi ben studiati e disposti secondo una logica funzionale si arriva alla bellezza dell'essenzialità: non solo l'arredo, ma un progetto integrato dell'ambiente.

Well-designed elements and placing according to a functional logic, you get to the beauty of essentiality: not only the furniture, but an integrated project of interior decoration.



315

Composizione
Composition



Grigio Lilla Iris

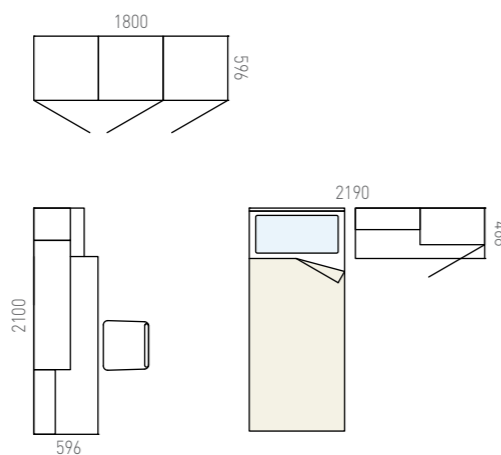

Pensile Tetris
abbinabile con pensili
universali



68

Infinite solutions
to give form to
your world:
creative projects
to express
in furnishing
your style vision.



INFINITE
SOLUZIONI
PER DARE
FORMA AL
TUO MONDO:
PROGETTI
CREATIVI
PER ESPRIMERE
NELL'ARREDO
LA TUA VISIONE
DELLO STILE



316

Composizione
Composition



Ponte complanare
sospeso con ante
scorrevoli facili da aprire



Una soluzione intelligente che sfrutta un'unica parete della stanza

A smart solution that uses a single wall room

Non c'è limite alla fantasia con una collezione che permette ogni soluzione, integrando contenitori ed elementi libreria sia pensili che a terra.

There is no limit to the imagination with a collection that allows each solution, integrating cabinet and library elements, hanging or on the floor.

316

Composizione
Composition

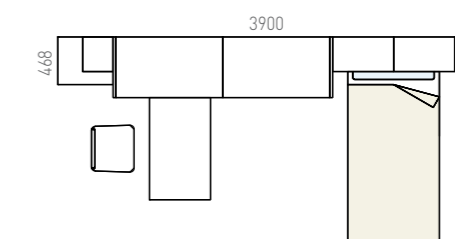
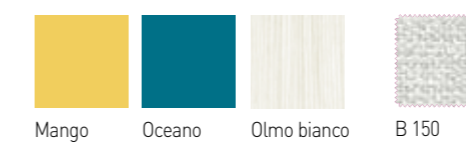



GLOBO
 La zona studio super
 attrezzata: pensili e scrittoio
 con tasca in tessuto

GLOBO
 The study area super equipped: wall units and
 desk with fabric pocket

Comodamente
 seduti sulla sedia
 ergonomica con ruote,
 in un ambiente vivace
 e ben organizzato, lo
 studio diventa molto
 più gradevole.

Comfortably seated on
 the ergonomic chair
 with wheels, in a lively
 and well organized
 place, the study
 becomes much more
 enjoyable.

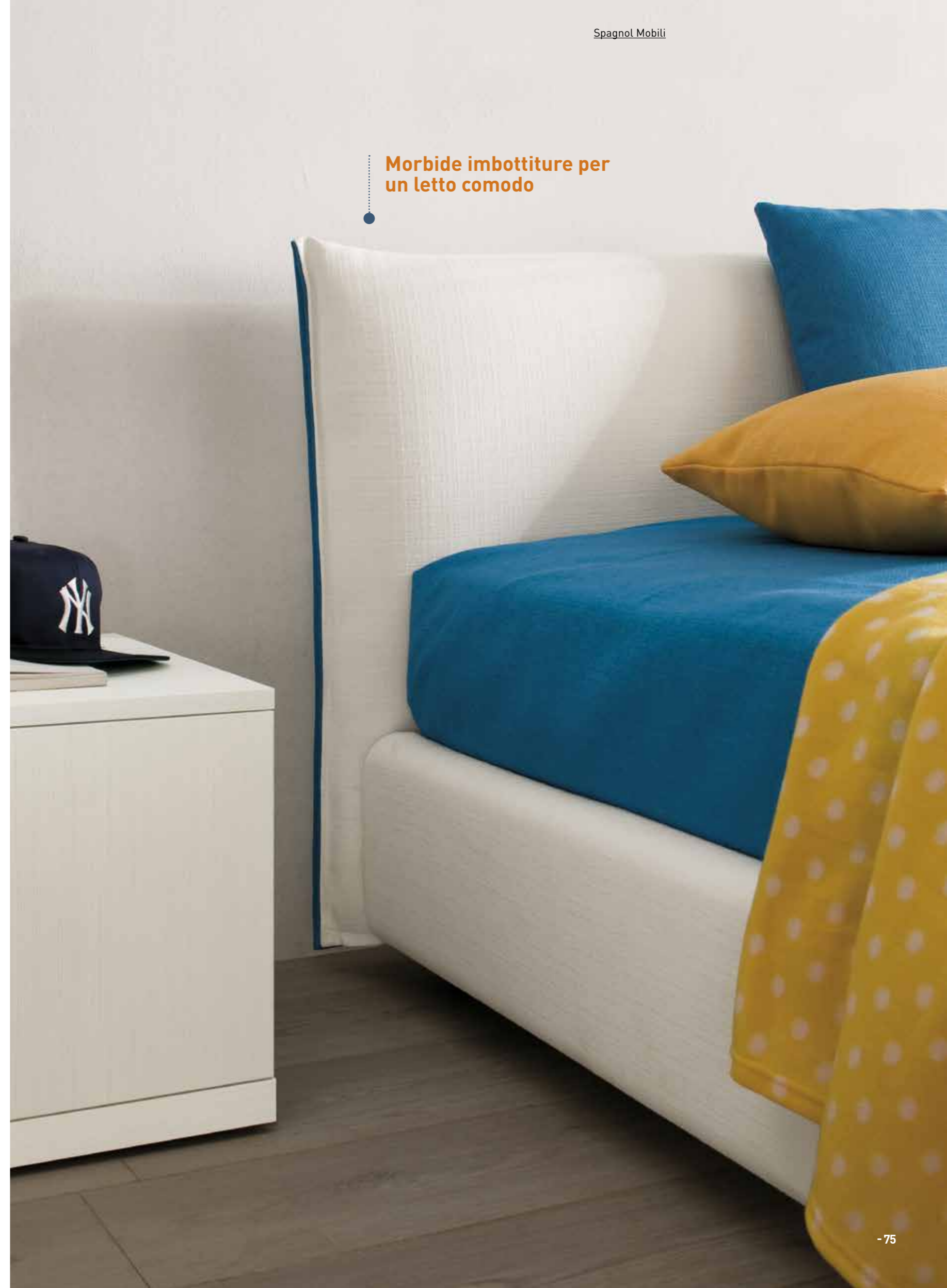
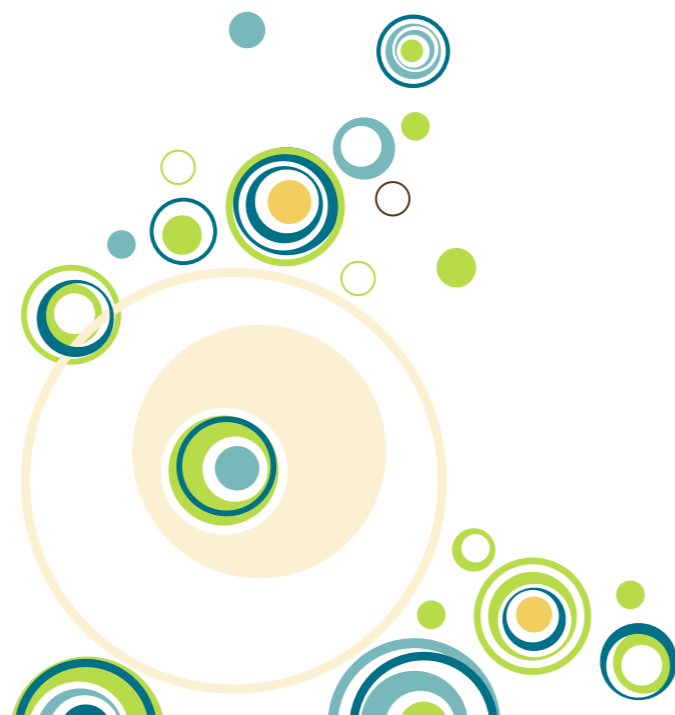

Morbide imbottiture per
 un letto comodo



317

Composizione
Composition



Letto Zen e piano scrittoio: due elementi importanti per organizzare lo spazio

Zen bed and desk top: two important elements to organize study space

Lo spessore del piano e il letto Zen con testiera e pediera a tre colori caratterizzano la composizione. L'estetica si unisce al comfort.

The thickness of the desktop and the Zen bed with headboard and footboard in three colors characterize the composition. The aesthetics meets comfort.

317

Composizione
Composition

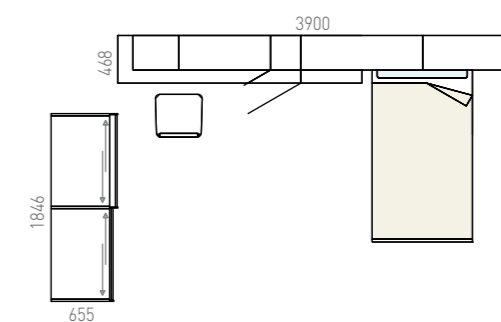
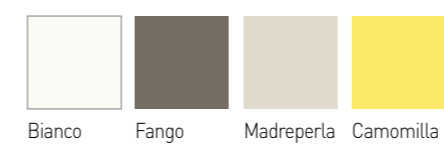

Armadio con ante scorrevoli Joint

Joint cabinet with sliding doors

La bellezza astratta del colore anima anche le ante scorrevoli Joint dell'armadio, un vero guardaroba capiente e funzionale.

The abstract beauty of color enlivens the Joint sliding doors of the wardrobe, a true spacious and functional closet.

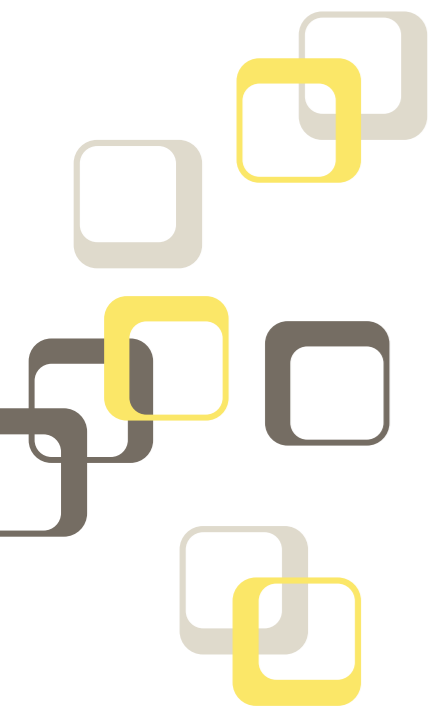

318

Composizione
Composition





Nascondigli segreti tante idee per riporre libri e giochi

Secret hideouts so many ideas for books and games

Lo spazio tra il letto e il muro è sfruttato con un pratico contenitore, mentre la sacca in tessuto rende più funzionale lo scrittoio.

The space between the bed and the wall is maximized with a practical holder, while the fabric bag makes the desk more functional.

318

Composizione
Composition

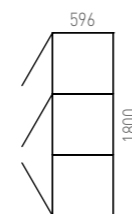
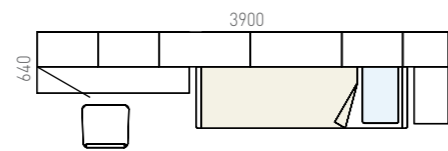
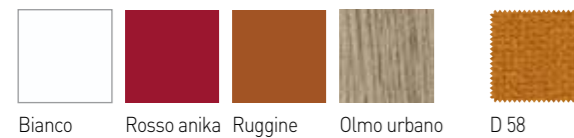



GLOBO
 lo scrittoio in essenza
 olmo urbano
 con pensili colorati

GLOBO
 the desk in essence urban elm
 with colored wall units

Luci led integrate e
 piano scrittoio in olmo
 urbano. La collezione
 introduce nelle
 camerette soluzioni e
 materiali di tendenza
 nell'interior design
 contemporaneo.

Integrated lights and
 writing desk elm urban.
 The collection
 introduces in the room
 solutions and trendy
 materials in contemporary
 interior design.

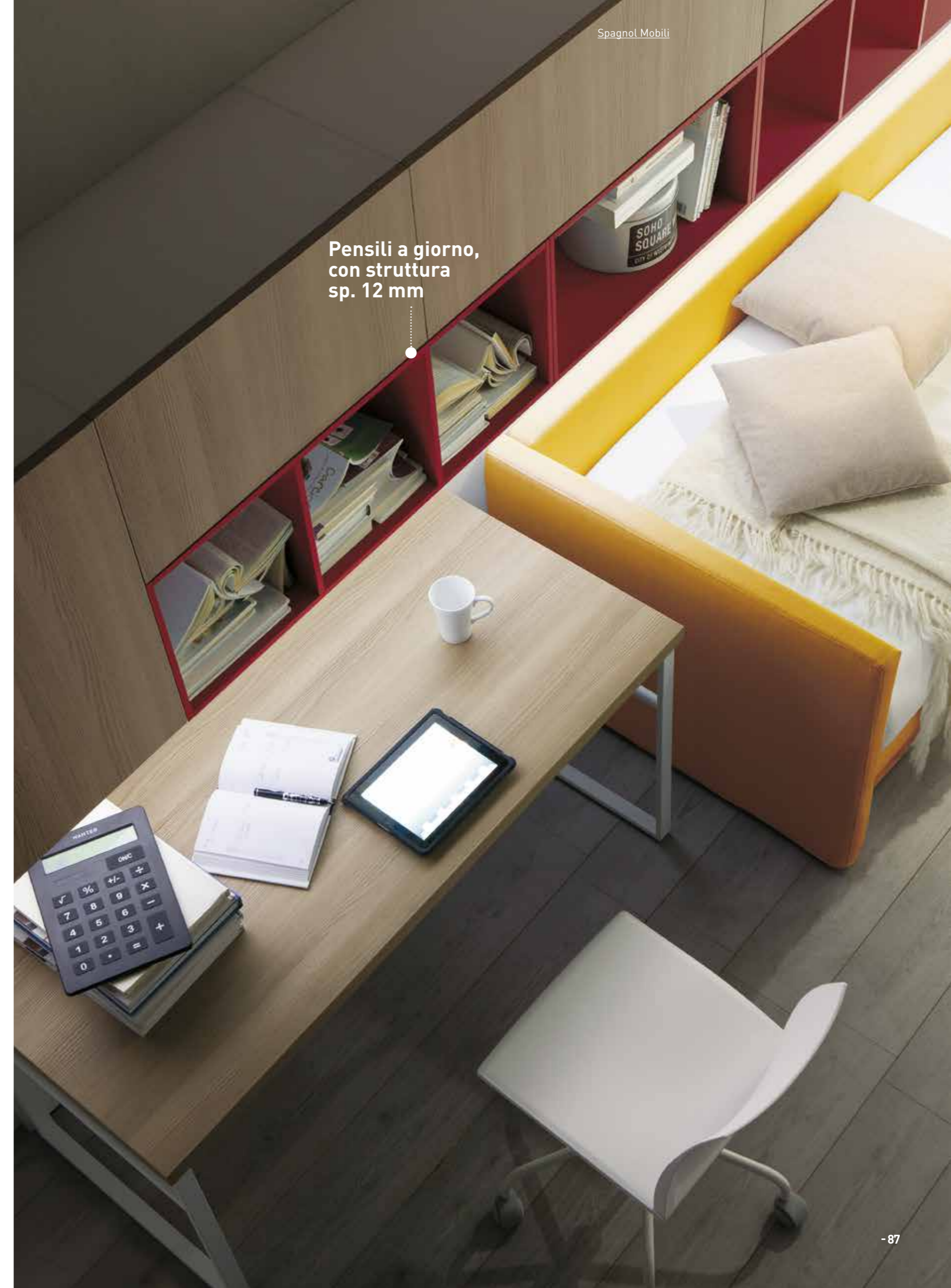

Pensili a giorno,
 con struttura
 sp. 12 mm

319

Composizione
Composition





L'angolo studio con tutto a portata di mano

The study area with everything on hand

Un'originale libreria composta da elementi giorno 1.2, una cassetiera su ruote, una base che è sia contenitore che comodino: una soluzione brillante.

An original library made by open elements 1.2, drawers on wheels, a base that is both an holder and a bedside table: a brilliant solution.

319

Composizione
Composition

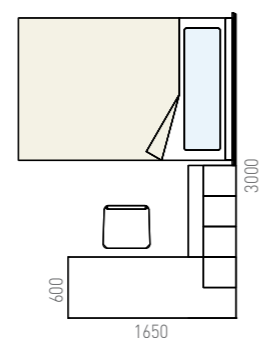

Pensili 1.2 colorati posizionabili a piacere







320

Composizione
Composition

La libreria è di moda con i colori e i pensili da disporre a parete

The library is fashionable with the colors and wall units to be placed on the wall

Lo scrittoio ha la regolarità geometrica dei fianchi e del piano spesso 58 mm; l'armadio ha due pratiche ante scorrevoli.

The desk has the geometric regularity of the sides and the desktop 58 mm thick; The cabinet has two practical sliding doors.

320

Composizione
Composition

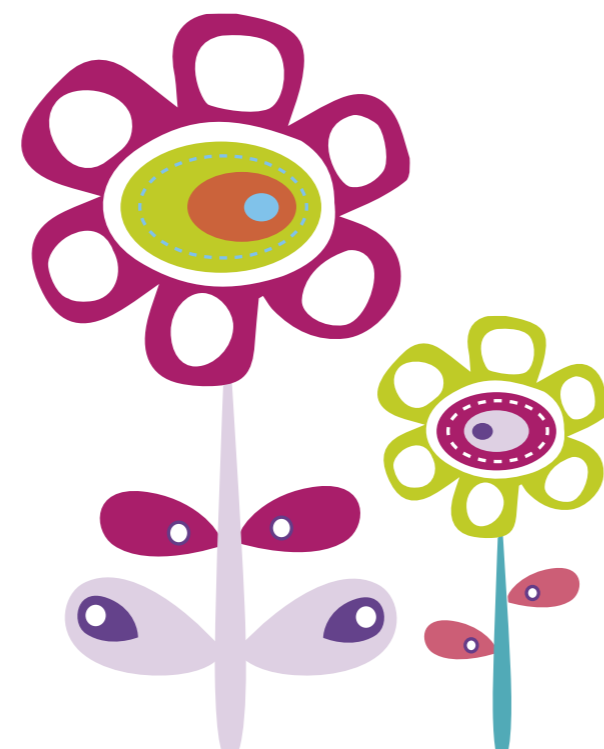
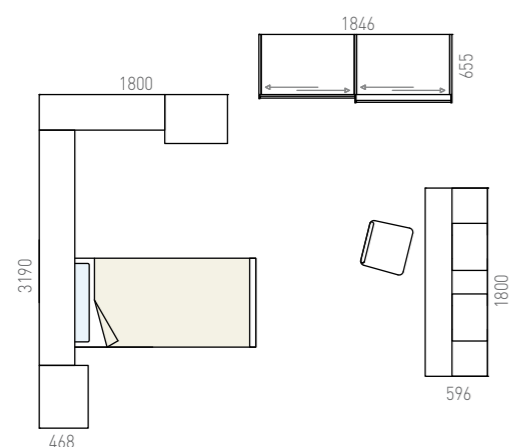
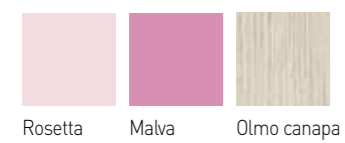

321

Composizione
Composition





Le mensole creano una vera libreria sopra la scrivania

The shelves create a real library over the desk

Le soluzioni sono sempre pratiche, come il pianale del letto Box che si allarga per diventare un'utile superficie d'appoggio.

The solutions are always practical, as the base of bed Box that expands itself to become a useful storage area.

321

Composizione
Composition

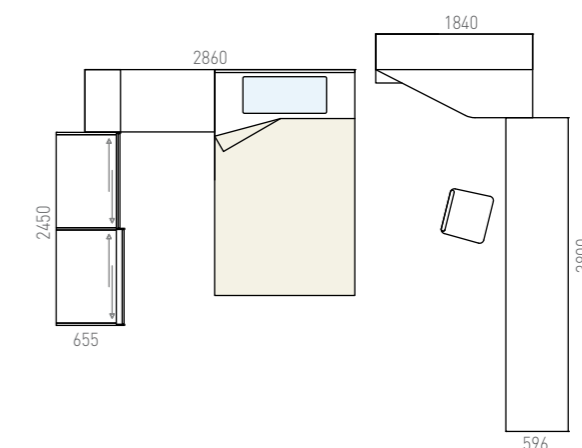



322

Composizione
Composition

Il grande scrittoio, la libreria con ripiani posizionati a piacere e il contenitore basculante.

The big desk, a bookcase with shelves positioned as desired and overhead cabinet.



Scegli il letto dei tuoi sogni: colori e forme per dare un tocco originale, con la massima comodità

Choose the bed of your dreams: colors and shapes to give an original touch, with the maximum convenience

Possibilità di combinare diverse testiere con 3 tipi di ring, con una pediera abbinata alla testiera oppure con il ring R2 con contenitore.

Possibility to combine different types of headboards with 3 types of rings, with a footboard coupled to headboards or with the ring R2 with box.

Testiera Teo con Ring R1
Bed with Ring R1



Testiera Tex con Ring R2
Bed with Ring R2



Testiera Twit con Ring R3
Bed with Ring R3



Testiera Mix con pediera abbinata
Bed with footboard combined



322

Composizione
Composition

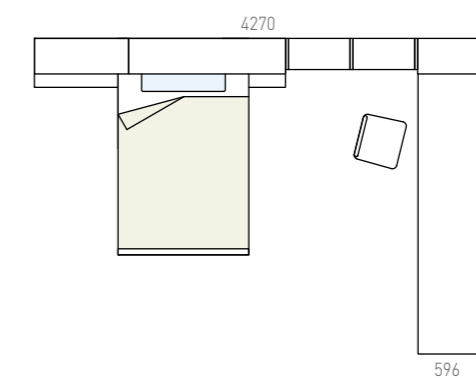
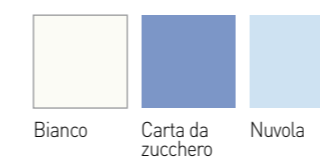



323

Composizione
Composition



Il pensile ha tutta la praticità e la simpatia dell'anta scorrevole.

The wall unit has all the convenience and friendliness of the sliding door.



La testiera del letto Card e il comodino si fondono in un'unica originale forma.

The headboard of the Card bed and the nightstand merge themselves into a single original form.

Giochi di forme e colori: un ambiente dolce e frizzante, originale come il tuo look, dove ogni cosa ha il suo posto

Games of shapes and colors: a sweet and sparkling place, original like your look, where everything has its place

323

Composizione
Composition

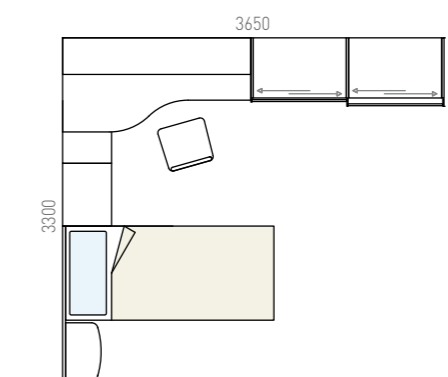

Le ante scorrevoli Joint sono un quadro geometrico

The sliding doors Joint are a geometric framework

In una camera giovane gli elementi devono essere pratici, robusti ma soprattutto originali. Come l'armadio a due ante scorrevoli Joint.

In a young room the elements must be practical, robust but especially original. As the cabinet Joint with two sliding doors.





324

Composizione
Composition



Un vero studio realizzato attorno al grande scrittoio con base libreria

A real study made around
the large desk with basic library

E poi l'armadio con
anta Centrale e
una composizione
di mensole per gli
oggetti più belli.

Then, the wardrobe
with door Centrale
and a composition
of shelves for the most
beautiful objects.

324

Composizione
Composition

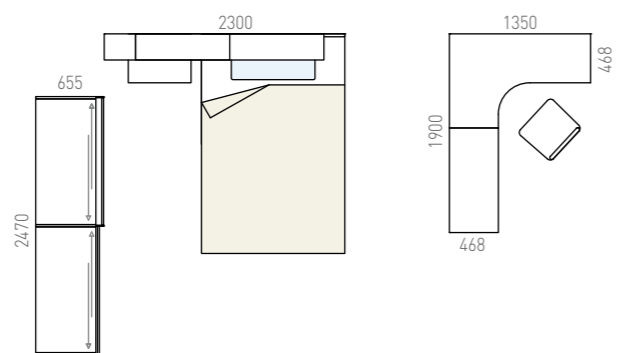



325

Composizione
Composition



Le ante portano un tocco di colore e proteggono gli oggetti più importanti.

The doors bring a touch of color and protect the most important objects.

Dietro la testiera del letto, il piano d'appoggio è come un grande comodino.

Behind the headboard of the bed, the top is as a great bedside.

325

Composizione
Composition

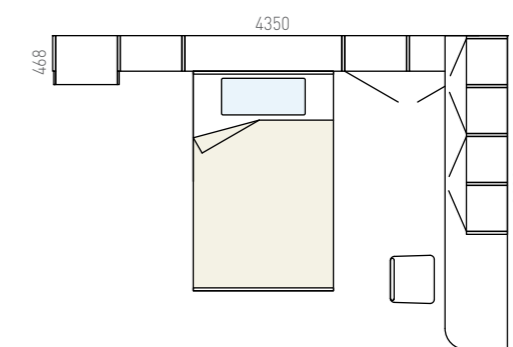



326

Composizione
Composition



La libreria continua con le mensole e il pensile con anta basculante

The library continues with shelves and wall unit with lift-up door

Letto imbottito Desi e scrittoio: ad ognuno il suo spazio.

Upholstered bed and desk Desi: to each one his own space.



326

Composizione
Composition

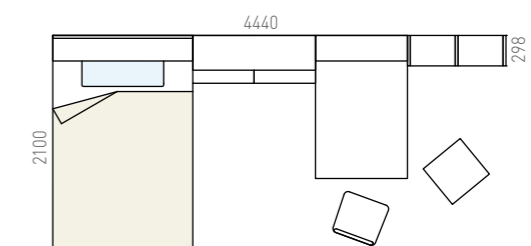
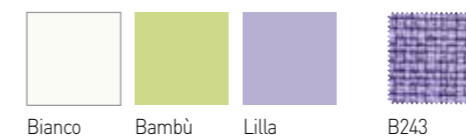



327

Composizione
Composition



La camera romantica nelle sfumature del rosa con testiera sagomata da vere principesse

The romantic room in shades of pink with shaped headboard for real princesses

Armadio, cassettera, letto: ogni elemento trasforma la sua funzione con un tocco di magia per inventare un'atmosfera da fiaba.

Cabinet, dresser, bed: all elements transform each function with one touch of magic to invent a fairy atmosphere.

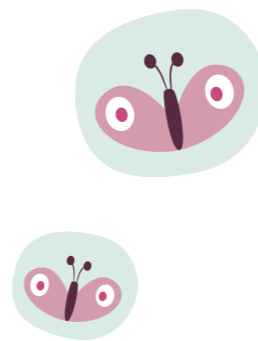

327

Composizione
Composition

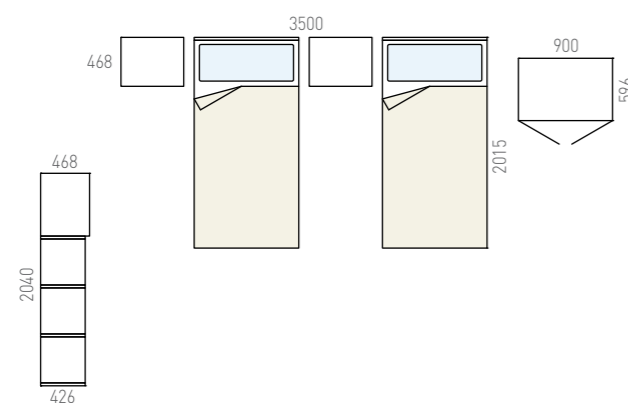
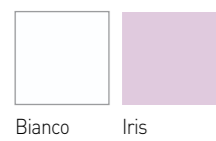



328

Composizione
Composition



Pisolo è un letto multifunzionale, con i led e il contenitore.
Pisolo is a multifunctional bed, with the LEDs and the box.

La bella armonia di colori del comodino con maniglie Disco.
Beautiful harmony of colors bedside with handles Disco.



328

Composizione Composition

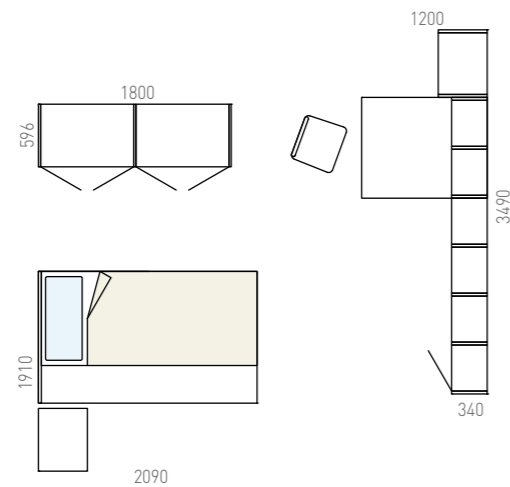



329

Composizione
Composition



Scegli i colori, disegna la struttura e scegli il letto scorrevole su binario o su ruote

Choose colors, designs the structure and choose the sliding bed on rails or wheels

Ci sono sempre molte possibilità nel progettare una camera Freestyle, dimensionando e abbinando gli elementi.

There are always many possibilities to design a room Freestyle, sizing and matching items.

329

Composizione
Composition

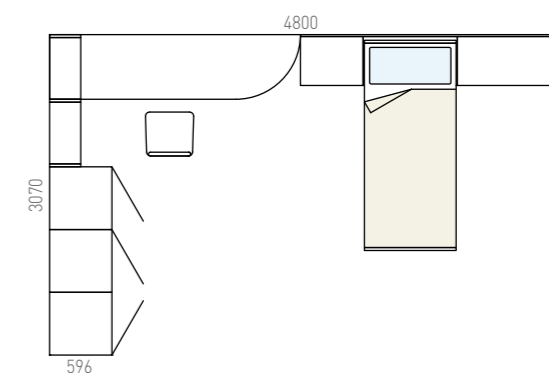



330

Composizione
Composition



Il disegno dello scrittoio sagomato ottimizza lo spazio.
The design of shaped desk maximizes space.

L'accogliente boiserie Max assieme al letto imbottito Easy con contenitore.
The cozy boiserie Max along with the upholstered bed Easy with storage.



Boiserie Max con illuminazione a luce led

330

Composizione
Composition

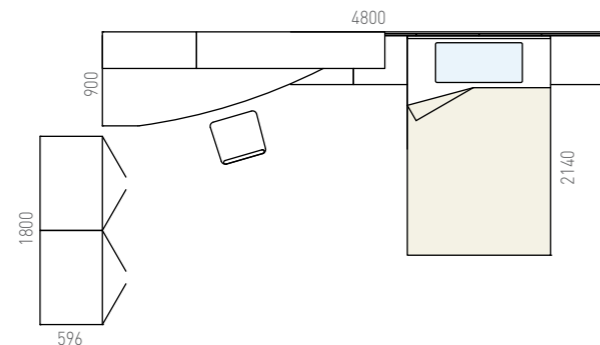



331

Composizione
Composition



La disposizione dei mobili rende l'organizzazione dell'ambiente più dinamica, pratica e funzionale.

The disposition of the furniture makes the space organization more dynamic, practice and functional.



331

Composizione
Composition

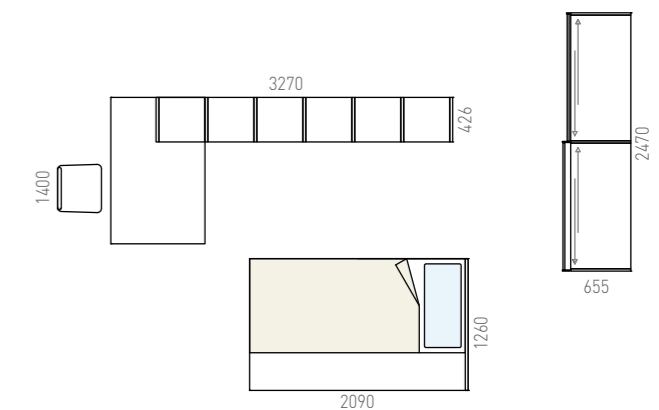



332

Composizione
Composition



Tutto a portata di mano con lo scrittoio integrato alla libreria Vega



Una nicchia per inserire il letto Eolo che è anche divano con un secondo letto estraibile

A niche to insert the bed Eolo which is also sofa with a second pull-out bed

Accogliere i compagni quando vengono a fare i compiti o un amico che si ferma a dormire: la camera è comoda in ogni occasione.

Welcome companions when they are doing homework or a friend who stops to sleep: the room is comfortable at every opportunity.



332

Composizione
Composition

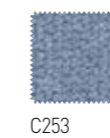
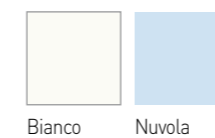

C253

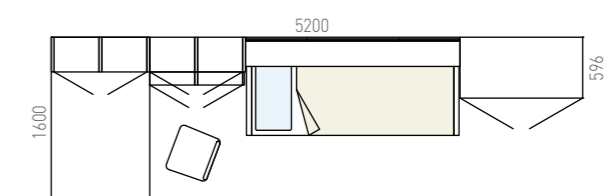



333

Composizione
Composition

GLOBO La camera come un open space

GLOBO
The room as an open space

Perfetta se si sta in famiglia, ideale se si va a vivere da soli, con il letto contenitore Eolo, il grande tavolo scrittoio e lo spazio per pouf e armadi.

Perfect if you're in the family, ideal if you go to live alone, with the bed with storage Eolo, the large table and the space for cabinets and pouf.

333

Composizione
Composition

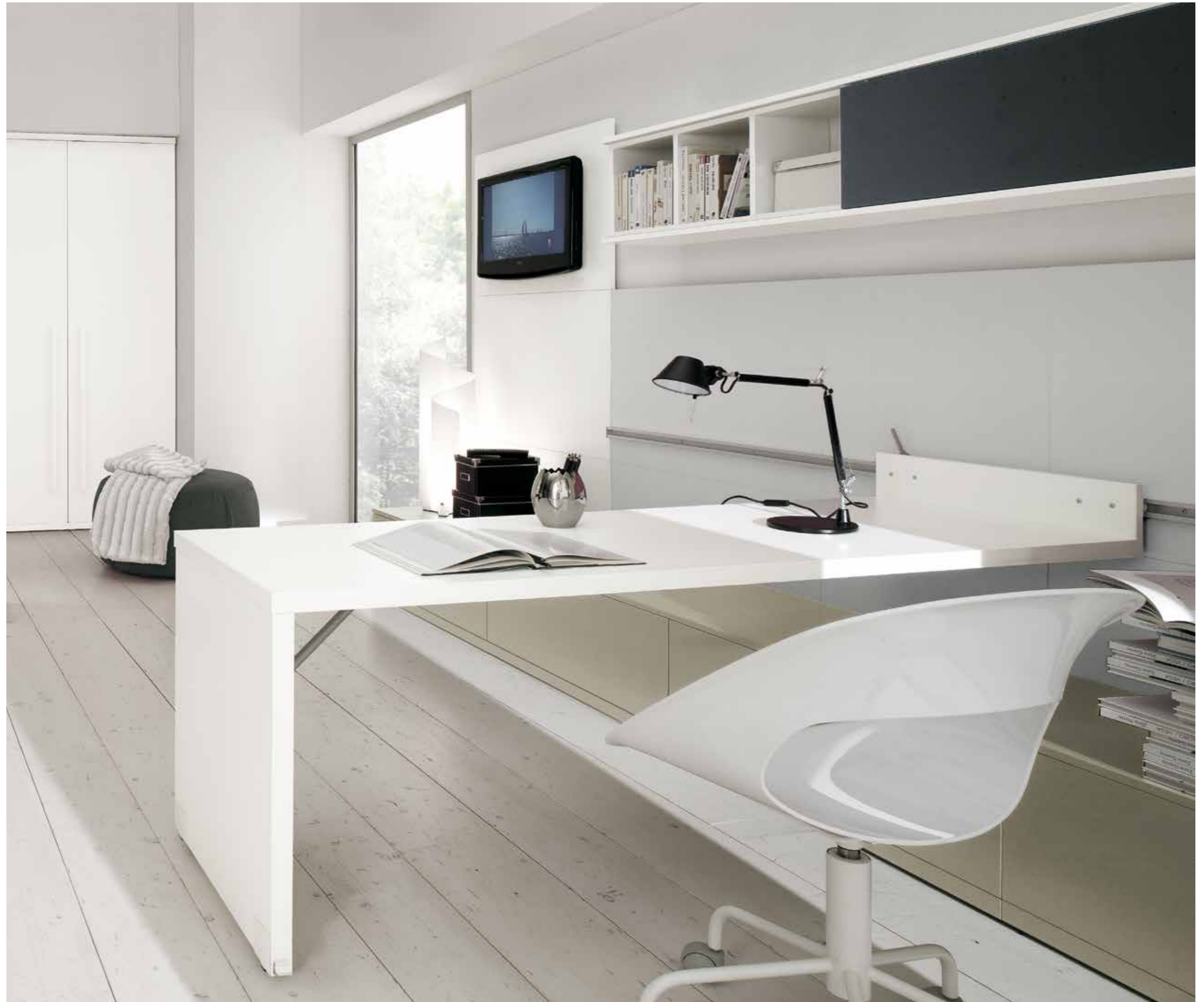
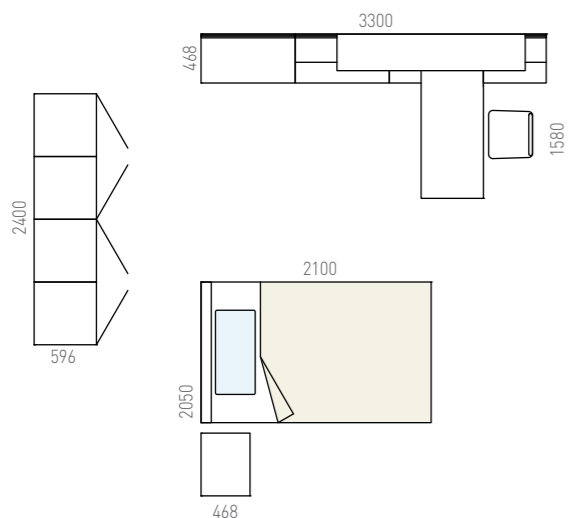
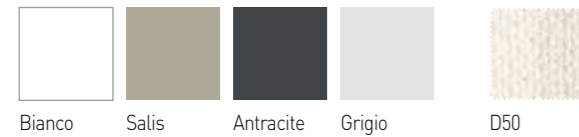

334

Composizione
Composition





La camera diventa grande nella scelta dei colori e nella dinamica delle funzioni

The room grows up with the choice of colors and dynamics of the functions.

Il gusto si evolve e la boiserie Max unisce mensole e contenitori, scrivania, letto e comodino in un'armonia essenziale e moderna.

The taste evolves and boiserie Max combines shelves and cabinets, desk, bed and bedside in an essential harmony and modern.



334

Composizione
Composition

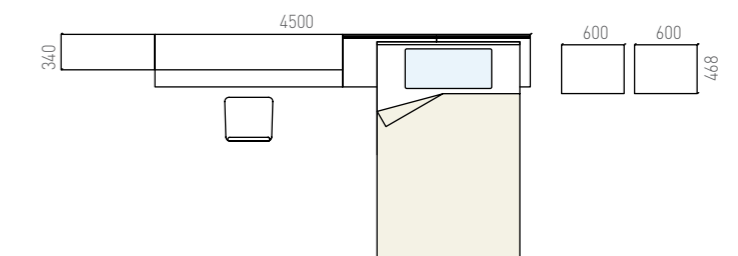
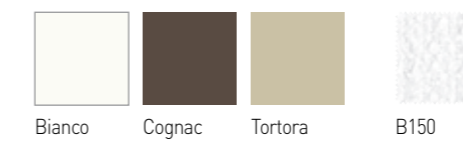



335

Composizione
Composition



Una boiserie per organizzare la parete con mensole e accessori porta CD e accessori

A boiserie organize the wall with shelves CD racks and accessories

È una struttura multifunzionale alla quale si possono abbinare letti con o senza testiera anche su ruote. I profili in alluminio della boiserie orizzontale la rendono leggera e robusta.

It is a multi-purpose facility which can be combined with or without headboard beds also on wheels. The aluminum profiles of the horizontal boiserie making it light and strong.

335

Composizione
Composition

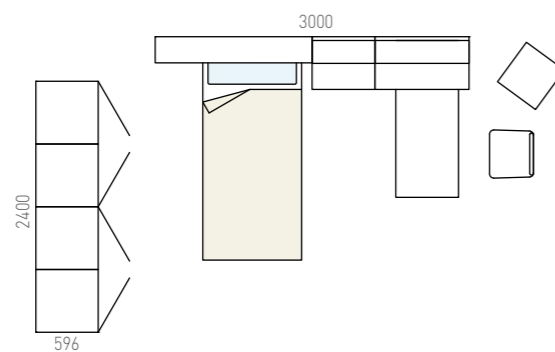

336

Composizione
Composition





La fantasia dei colori e dei tessuti e un moderno progetto libreria

The imagination of colors and fabrics and a modern library project

Soluzioni originali come la libreria del programma Archimede e una boiserie orizzontale da personalizzare con gli accessori.

Original solutions such as program Archimede and a horizontal boiserie to customize with accessories.

336

Composizione
Composition

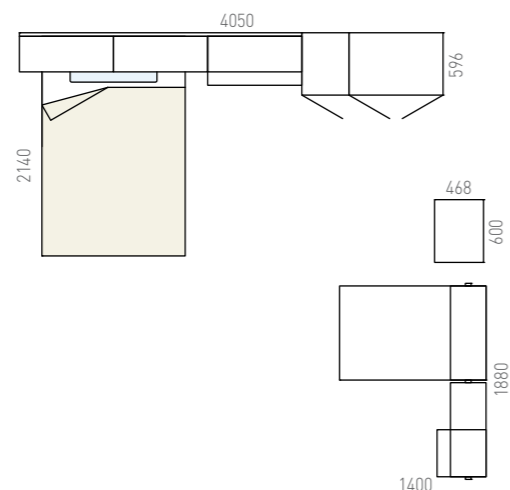
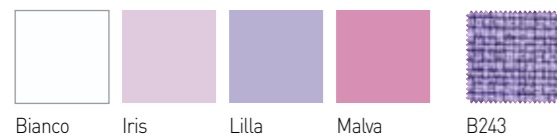

337

Composizione
Composition



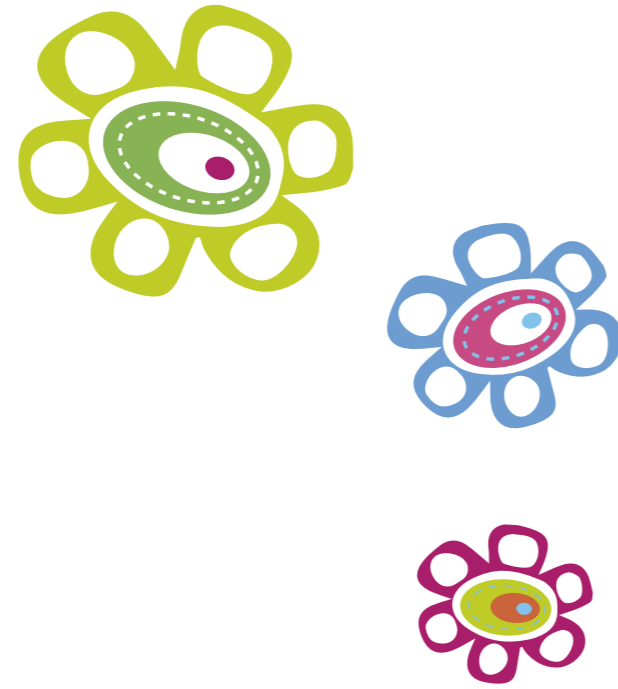

Soluzioni salva spazio

Solutions save space

Il fianco centrale in metallo permette di creare un unico ponte per lo scrittoio e il letto.
The center metal side allows to create a unique bridge between the desk and the bed.

337

Composizione
Composition

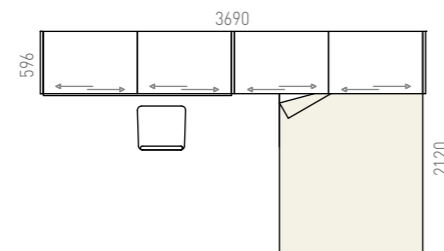

168

collection

PENSILI

—
The bookcase modules are a useful and colourful way of equipping the wall by exploiting the area with versatile containers.

I PENSILI
SONO DEGLI
ELEMENTI UTILI
E COLORATI PER
ATTREZZARE
LA PARETE
SFRUTTANDONE
LA SUPERFICIE
CON DEI
VERSATILI
CONTENITORI

pensili TETRIS

struttura sp. 1,2 cm

Una forma geometricamente originale e una concezione che spinge al gioco e al libero posizionamento: Tetris è il pensile dinamico che dà un nuovo slancio alla libreria.

A geometrically original shape and a conception that pushes to the game and the free placement: Tetris is the dynamic wall unit that gives a new impetus to the library.

Finiture disponibili: in tutti i colori laccati opachi, lucidi e metal
Only available in matt, gloss and metal lacquered as color



Tetris abbinabile ai pensili 1.2 - Tetris with wall units 1.2

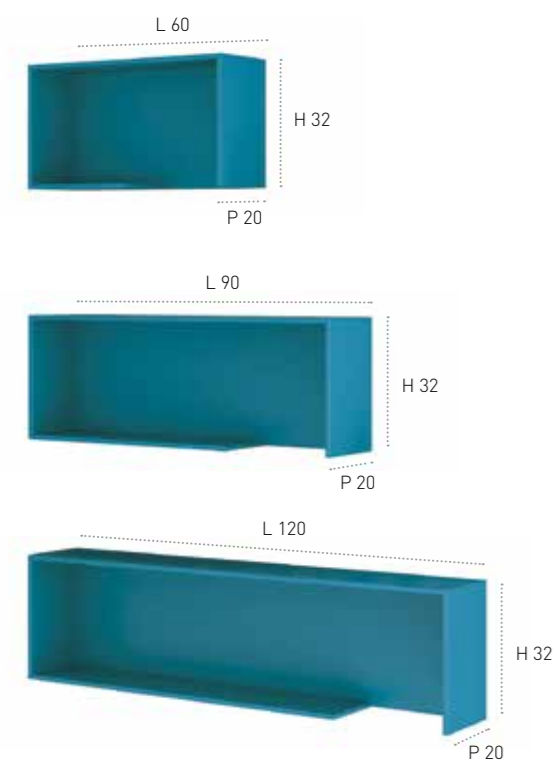

Esempi di componibilità - Modular examples

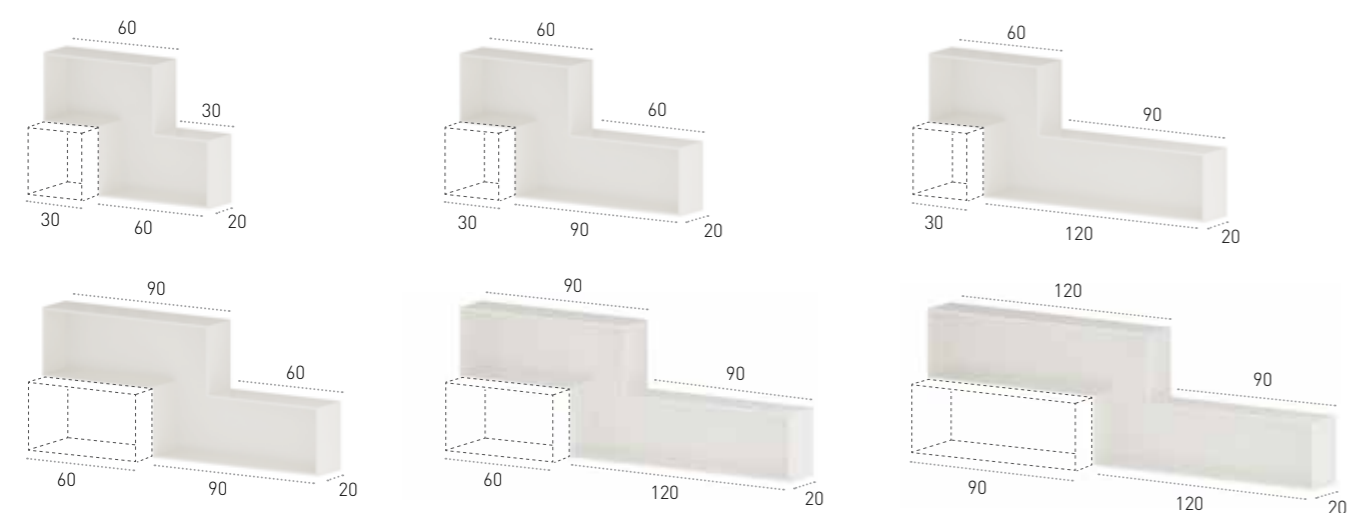

pensili ESAGONO

struttura sp. 1,2 cm

E' un'idea modulare estremamente versatile. Si creano composizioni personalizzate, mescolando i colori della collezione per completare la funzionalità dello scrivitorio o per avere, dove serve, delle mensole con o senza fianco di protezione, spesse 12 mm, belle da vedere e comode da usare.

It is an idea extremely versatile and modular. You create custom compositions, mixing colors of the collection to complete the functionality of the desk or to have, where it is needed, shelves with or without side protection, 12 mm thick, beautiful to look at and comfortable to use.



Finiture disponibili: in tutti i colori laccati opachi
Only available in matt lacquered as color

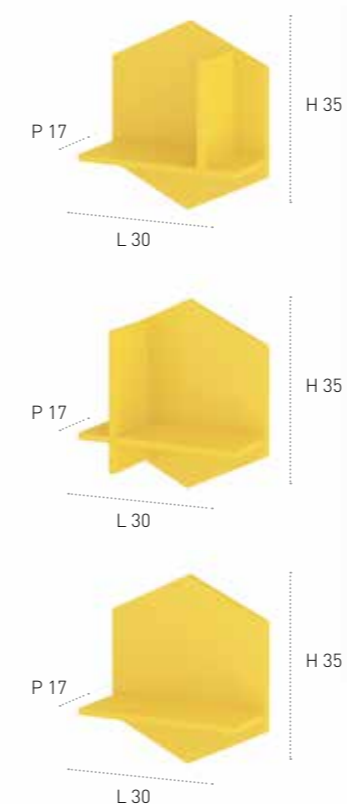

pensili KUBIK

struttura sp. 1,2 cm

Kubik è un complemento modulare molto pratico: i divisori interni lo rendono utilizzabile come libreria ma anche come porta oggetti, CD e DVD in composizioni libere.

Kubik is a very practical complement: the internal dividers make it usable as a library as well as holder of objects, CDs and DVDs in free compositions.

Finiture disponibili: in tutti i colori laccati opachi, lucidi e metal
Only available in matt, gloss and metal lacquered as color



pensili KUBIK 2

struttura sp. 1,2 cm

Moduli da posizionare in orizzontale o in verticale, aperti alle estremità e con fianchi interni, per creare librerie dinamiche, autonome o integrate alla composizione.

Modules to be placed horizontally or vertically, open at both ends and with internal dividers to create dynamic libraries, stand-alone or integrated to the composition.

Posizionabili in orizzontale o in verticale
They can be positioned horizontally or vertically

Finiture disponibili: in tutti i colori laccati opachi, lucidi e metal
Only available in matt, gloss and metal lacquered as color

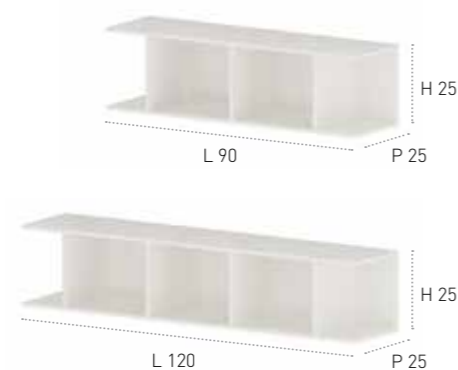

pensili PENSILI 1.2

struttura sp. 1,2 cm

Una linea di pensili a giorno con o senza ante da posizionare liberamente sulla parete sfruttando la grande modularità per creare composizioni versatili e multifunzionali.

A range of wall units with or without a door to be placed freely on the wall taking advantage of the high modularity to create versatile and multifunctional compositions.

Struttura disponibile nelle finiture nobilitato bianco, madreperla, olmo bianco, canapa, urbano, monteago, laccato opaco, laccato lucido e metal. Ante disponibili nelle versioni light, laccato poro aperto, lux e metal.
Structure available in bianco melamine finish, madreperla, olmo bianco, canapa, urbano, monteago matt lacquered, glossy lacquered and metal. Doors available in light, open pore lacquered, metal and lux.

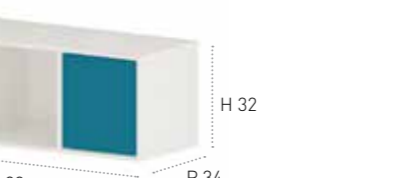
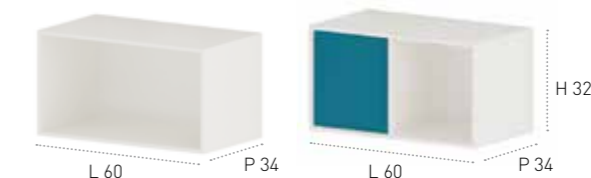
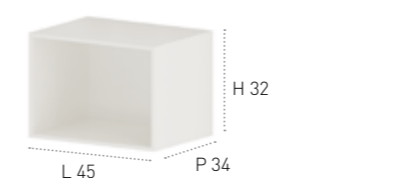
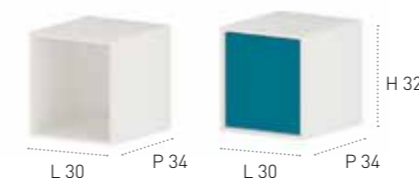

174

letti

ESSENZA COLORE

Spagnol collection
expresses the pleasure
of form, value comfort
and a look that is
always fresh and young
with the cozy warmth
of wood essence and
the cheerful and
vivid colors.

LA COLLEZIONE
SPAGNOL
ESPRIME LA
PIACEVOLEZZA
DELLA FORMA,
IL VALORE DEL
COMFORT E UN
LOOK SEMPRE
FRESCO E
GIOVANE CON
L'ACCOGLIENTE
CALORE
DELL'ESSENZA
E L'ALLEGRA
VIVACITÀ DEI
COLORI

letti ESSENZA/COLORE

L'olmo in quattro tonalità più il bianco e il madreperla: essenze moderne ideali per la camera dei ragazzi. Il colore laccato opaco in 48 tinte: si spazia da quelle più di tendenza a quelle classiche, da quelle più vivaci a quelle neutre. La scelta tra i diversi tipi di Ring, esprime liberamente il proprio stile.

The elm in four colors plus white colour and mother of pearl: modern essences ideal for children's bedrooms. The matt lacquered color in 48 tints: ranging from the most trendy to classic, from the most vibrant to neutral ones. The choice between the different types of bed frames, expresses freely his own style.

6 finiture nobilitato / melamine finishes

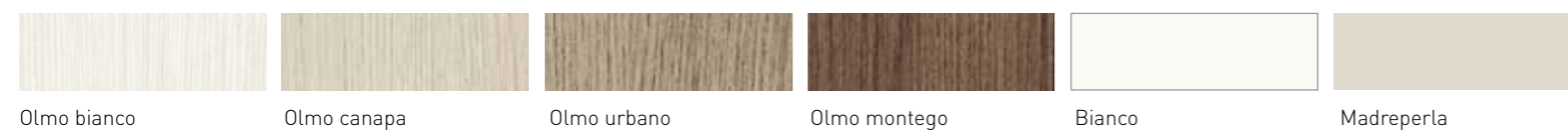

Olmo bianco Olmo canapa Olmo urbano Olmo montego Bianco Madreperla

48 laccati opachi / matt lacquered



Letto con ring R1
Bed with ring R1



Letto con ring R2
Bed with ring R2



Letto con ring R3
Bed with ring R3



Letto con pediera abbinata
Bed with footboard combined



LETTI

Beds

RING R1



Rete da 82/92 - 122/162

RING R2



Rete da 82/92 - 122/162

RING R2 c/contenitore



Rete da 82/92 - 122/162

RING R3



Rete da 82/92 - 122/162



Letto **ANTARES** con **pediera abbinata**
Disponibile anche con RING R1 - R2



Letto **ARI** con **RING R1**
Disponibile solo con rete L 82/92
anche con RING R2 - R2 CONT - R3



Letto **CAT** con **pediera abbinata** [solo rete 82-92]
Disponibile anche con RING R1 - R2 - R2 CONT
pediera abbinata cont.



Letto **EROS** con **RING R3**
Disponibile solo con rete L 92



Letto **BLOOM** con **RING R1**
Disponibile anche con R2 - R2 CONT
e **pediera abbinata**



Letto **BOOK** con **RING R3**
Disponibile solo con rete L 82



Letto **FLOCK** con **RING R3**



Letto **FLY** con **pediera abbinata**
Disponibile solo con rete L 82-92
anche con RING R1 - R2 - R2 CONT
pediera abbinata cont.



Letto **BRIO** con **RING R3**



Letto **CARD** con **RING R3**
Disponibile solo con rete L 82



Letto **GATE** con **RING R3**



Letto **SIRIO** con **pediera abbinata**
Disponibile anche con RING R1 - R2

LETTI

Beds

RING R1



Rete da 82/92 - 122/162

RING R2



Rete da 82/92 - 122/162

RING R2 c/contenitore



Rete da 82/92 - 122/162

RING R3



Rete da 82/92 - 122/162



Letto **STAR** con **pediera abbinata**
Disponibile solo con rete L 82-122-162
anche con RING R1 - R2



Letto **MELA** con **RING R3**
Disponibile solo con rete L 82



Letto **MIX** con **pediera abbinata**
Disponibile solo con rete L 82-92
anche con RING R1 - R2 - R2 CONT
pediera abbinata cont.



Letto **TENDER** con **RING R2**
Disponibile anche con RING R1 - R2 CONT - R3



Letto **TEO** con **RING R1**
Disponibile solo con rete L 82-92
anche con RING R2 - R2 CONT - **pediera abbinata**
pediera abbinata cont.



Letto **PRETTY** con **RING R3**



Letto **SLIM** con **RING R1**
Disponibile anche con RING R2 - R2 CONT
pediera abbinata - pediera abbinata cont.



Letto **TEX** con **RING R2**
Disponibile solo con rete L 82-92
anche con RING R2 CONT - R3



Letto **TWIT** con **RING R3**



Letto **SOL** con **RING R2** [solo rete 82-92]
Disponibile anche con R2 CONT - R3



Letto **SONG** con **RING R2**
Disponibile anche con RING R1 - R2 CONT - R3



Letto **UP** con **pediera abbinata**
Disponibile solo con rete L 82-92-122
anche con RING R1 - R2 - R2 CONT - R3
pediera abbinata cont.



Letto **ZEN** con **pediera abbinata**
Disponibile solo con rete L 92-122
anche con RING R1 - R2 - R2 CONT
pediera abbinata cont.

TURCHE

Independent bed

RETE DA 82 / 92 cm
SLATTED BASE FROM 82/92 cm



Turca **BLOOM**
Disponibile anche con rete estraibile per materasso H 20 cm



Turca **CAT**



Turca **FLY**



Turca **MIX**



Turca **SLIM**
Disponibile anche con rete estraibile per materasso H 20 cm



Turca **STAR** (disponibile solo con rete L 82)



Turca **TEO**



Turca **SIRIO**



Turca **UP**



Turca **ZEN**

DIVANI LETTO

Beds sofa

RETE DA 82 cm
SLATTED BASE FROM 82 cm



Divano Letto **FLY**



Divano Letto **MIX**



Divano Letto **SLIM**



Divano Letto **UP**

ESTRAIBILI SOTTO LETTO

Extractable



Letto estraibile
Extractable bed



Coppia cassetti estraibili con ruote
Couple of drawers with wheels

letti IMBOTTITI

Il letto arreda, non solo per la forma, ma soprattutto per la scelta dei rivestimenti. La collezione dei tessuti mette a disposizione la fantasia dei decori con una vasta gamma a vostra scelta. La forza espressiva dei colori e la sensazione dei materiali per trasformare ogni letto in un oggetto di design unico e personale, in una camera ricca di stimoli e creatività.

The bed furnishes, not only for the shape, but especially for the choice of the coatings. The collection of fabrics provides the fancy decorations with a variety of choice. The expressive power of color and the feel of the materials to transform any bed into a unique and personal design, in a room full of stimulus and creativity.



CREA IL TUO STILE CON OLTRE 300 TESSUTI

Scegli sul campionario le infinite possibilità di fantasie e colori in tessuto o in ecopelle.

Choose on the sample the endless possibilities of patterns and colors in fabric or leather.

LETTI IMBOTTITI "SFODERABILI"

Upholstered beds "removable"

RETE DA 80 / 90 / 120 / 160 cm
SLATTED BASE FROM 80 / 90 / 120 / 160 cm

RING Ri1



RING Ri2



RING Ri3



RING Ri4



RING Ri5



RING Ri6



Letto **DESI** con RING Ri6



Letto **LUXOR** con RING Ri5
Disponibile anche con RING Ri1 - Ri2 - Ri3



Letto **LOVE ME** con RING Ri3
Disponibile anche con RING Ri1 - Ri2



Letto **STEP** con RING Ri4
Disponibile anche con RING Ri1 - Ri2



Letto **VERTIGO** con RING Ri4
Disponibile anche con RING Ri1 - Ri2

PROGRAMMA LETTI IMBOTTITI "SFODERABILI"

Program upholstered beds "removable"

MODELLO EASY

RETE DA 80 cm
SLATTED BASE FROM 80 cm



Letto singolo
Single bed



Predisposizione 2° letto
2nd bed arrangement



Predisposizione cassetti
Drawers arrangement

MODELLO EOLO

RETE DA 80/120 cm
SLATTED BASE FROM 80/120 cm



Letto singolo
Single bed



Predisposizione 2° letto
2nd bed arrangement



Predisposizione cassetti
Drawers arrangement



Letto contenitore
Open holder

MODELLO PISOLO

RETE DA 120 cm
SLATTED BASE FROM 120 cm



Letto
Bed



Predisposizione 2° letto
2nd bed arrangement



Predisposizione cassetti
Drawers arrangement



Letto con materasso da 90 e panca
Bed with mattress 90 and bench



Letto contenitore con materasso da 90 e panca
Bed with holder mattress 90 and bench



Letto contenitore
Open holder

DIVANI LETTO IMBOTTITI "SFODERABILI"

Upholstered sofa beds "removable"

RETE DA 80 cm
SLATTED BASE FROM 80 cm

MODELLO EASY



Divano letto
Upholstered sofa beds



Predisposizione 2° letto
2nd bed arrangement



Contenitore con ap. laterale
Holder with lateral opening



Divano letto
Upholstered sofa beds



Predisposizione cassetti
Drawers arrangement



Contenitore con ap. laterale
Holder with lateral opening

MODELLO EOLO



Divano letto
Upholstered sofa beds



Predisposizione 2° letto
2nd bed arrangement



Contenitore con ap. laterale
Holder with lateral opening



Divano letto
Upholstered sofa beds



Predisposizione 2° letto
2nd bed arrangement



Predisposizione cassetti
Drawers arrangement



Contenitore con ap. laterale
Holder with lateral opening

TURCHE IMBOTTITE "SFODERABILI"

Upholstered independent bed "removable"

RETE DA 80 / 90 / 120 / 160 cm
SLATTED BASE FROM 80 / 90 / 120 / 160 cm



Turca **OVER** con RING Ri1 - Ri2



Turca **SIDE** con RING Ri3



Turca **END** con RING Ri4

RETE DA 80 cm
SLATTED BASE FROM 80 cm



Turca **EASY**



Predisposizione 2° letto
2nd bed arrangement



Predisposizione cassetti
Drawers arrangement

POUF

Pouf



QUADRO
40x40



SOFTY
50x50



KUBICO
70x70



OBELIX
Ø 55



OBELIX
Ø 75



MAGIC trasformabile
70x76 (aperto 76x202)



POLTRONCINE

Armchairs



STYLO



SPACE



LULÙ



ALISON



DIVA

SEDIE

Chairs



JENNY
con gambe



JENNY
con ruote



JENNY imbottita
con gambe



JENNY imbottita
con ruote



SIRIO



QUADRO ASOLA



QUADRO ROTONDO



FIORE



CUORE



OLA

GAMBE PER PIANI SCRITTOI

Legs for writing desk

Una forma per ogni stile. Lo scrittoio è sempre personalizzato e si crea abbinando una delle molteplici sagomature del piano ad una delle tante tipologie di gambe della collezione.

A form for each style. The writing desk is always personalized with many shapes of the desk and with many types of legs of the collection.



Piano sospeso Jump
Jump hung top



Pannello sp. 3,8 / 5,8 cm
Panel sp. 3,8 / 5,8 cm



Cono su ruote
Cone on wheels



Cono
Cone



Cilindro
Cylinder



Corner
Corner



King
King



King su ruote
King on wheels



Cavalletto
Easel



Factor
Factor



Factor su ruote
Factor on wheels

192

collezione

ARMADI

It is not just an irreplaceable holder, but a perfectly organized and equipped volume that becomes a furniture component thanks to the design and the doors decoration. Both it has hinged or sliding door and it is walk-in, Spagnol wardrobe is always a surprise with its versatility.

NON È SOLO UN
CONTENITORE
INSOSTITUIBILE,
MA UN VOLUME
PERFETTAMENTE
ORGANIZZATO E
ATTREZZATO CHE
DIVENTA OGGETTO
D'ARREDO CON
IL DESIGN E LA
DECORAZIONE
DELLE ANTE. CHE
SIA BATTENTE,
SCORREVOLE O
CABINA, L'ARMADIO
SORPRENDE
SEMPRE PER LA
SUA VERSATILITÀ

ARMADI

BATTENTE E SCORREVOLE

Immaginalo con il sistema d'apertura che preferisci. Progetta con ripiani, cassettiere e accessori. Abbinare l'anta che preferisci e poi colorarla con la mazzetta Spagnol che spazia dalle tinte più innovative a quelle classiche, da quelle neutre a quelle vivaci, oppure vestilo con le calde venature di una delle quattro essenze della collezione e crea un armadio tutto per te.

Think to the opening system you prefer. Design it with shelves, drawers and accessories. Combine the door that you prefer and paint it with a color of the range of Spagnol collection, from the most innovative to the classic colors, from neutral to bright ones, or wear it with one of the warm four essences of the collection and creates yours wardrobe.

1 finitura nobilitato / melamine finishes

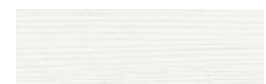

Per struttura interna armadio scorrevole e cassettiere interne
For internal sliding wardrobe structure and internal drawer unit

Bianco millerighe

6 finiture nobilitato / melamine finishes



Olmo bianco Olmo canapa Olmo urbano Olmo montego Bianco Madreperla

48 laccati opachi / matt lacquered



29 laccati lucidi / gloss lacquered



Struttura interna / esterna

6 finiture nobilitato / 48 colori opachi / 29 colori lucidi / 3 laccati opachi metallizzati

Structure Internal / External

6 melamine finishing / 48 matt colors / 29 glossy colors / 3 metal lacquers

Ante

16 finiture nobilitato / 48 colori opachi / 29 colori lucidi / 3 laccati opachi metallizzati

Door

16 melamine finishing / 48 colors matt / 29 colors glossy / 3 metal lacquers

Cassettiera interna

Bianco millerighe

Internal drawers
Bianco millerighe

3 laccati metal / metal lacquers



16 finiture nobilitato per frontali Spazio (ante battenti e cassetti) / melamine finishes for door Spazio (doors and drawers)

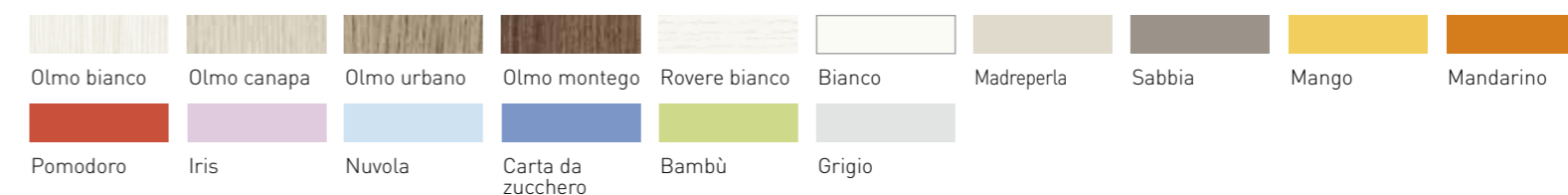

FRONTALI (ANTA BATTENTE E CASSETTO)

Front



FRONTALI / FRONT SPAZIO

Pannello nobilitato sp.18 mm con bordo ABS sp.1 mm su tutti i lati, in finitura Olmo bianco, canapa, urbano, montego, rovere bianco, bianco, madreperla, sabbia, mango, mandarino, pomodoro, bambù, iris, nuvola, carta da zucchero e grigio.

Melamine 18 mm thick with 1 mm thick ABS edging on all sides, finish white elm, hemp, urban, montego, white oak, white, pearl, sand, mango, tangerine, tomato, bamboo, irises, cloud, sugar paper and grey.



FRONTALI / FRONT LIGHT



Pannello nobilitato sp.18 mm con bordo ABS sp.1 mm in tutti i lati, finitura nei colori laccati opachi con vernici all'acqua atossiche.

Chipboard 18 mm with 1 mm thick ABS edging on all sides, finished in matt colors with non-toxic water-based paints.



FRONTALI / FRONT LACCATO PORO OPACO



Pannello nobilitato sp.18 mm in finitura poro aperto rovere con bordo ABS sp.1 mm su tutti i lati, finitura nei colori laccati opachi con vernici all'acqua atossiche.

Chipboard 18 mm in open pore dark oak finish with 1 mm thick ABS edging on all sides, finished in matt colors with non-toxic water-based paints.



FRONTALI / FRONT METAL

Pannello nobilitato sp.18 mm con bordo ABS sp.1 mm in tutti i lati, laccato con vernici goffrate opache atossiche con finitura perla metallizzato, gold metallizzato, titanio metallizzato.

Melamine 18 mm thick with 1 mm thick ABS edging on all sides, embossed with matt lacquered no-toxic with metallic pearl finish, gold metallic, titanium metallic.



FRONTALI / FRONT LUX

Pannello nobilitato sp.18 mm con bordo ABS sp.1 mm su tutti i lati, finitura nei colori laccati lucidi.

Chipboard 18 mm with 1 mm thick ABS edging on all sides, finished in glossy lacquered colors.



PERSONALIZZA LE ANTE DELL'ARMADIO CON LA TUA IMMAGINE PREFERITA

Ti proponiamo alcuni esempi di come il tuo armadio può diventare un quadro, riproducendo a tutta grandezza una tua foto o il disegno che vuoi. La serigrafia può essere fatta su ante (battenti e scorrevoli), fianchi, pannelli boiserie e pannelli al mq.

We offer you few examples of how your closet can be painted, reproduction your photo or design in big dimensions. Serigraphy can be done on doors (hinged or sliding), side panels, wall panels and panels per square meter.



FRONTALI / FRONT MOVIE

Pannello nobilitato sp. 18 mm con bordo ABS 1 mm nei 4 lati, laccato con vernici all'acqua goffrate opache atossiche, serigrafia a getto d'inchiostro.

Melamine sp. 18 mm with 1 mm ABS edge in the 4 sides, lacquered embossed matt with non toxic water-based paint, ink jet silkscreen.

Serigrafia Movie disponibile su ante, fianchi, pannelli boiserie e pannelli al mq

L'anta Light si trasforma in Movie con la serigrafia delle tue immagini preferite. E il look della camera non ha più limiti. **Queste sono alcune delle texture che noi proponiamo, ma si possono serigrafare anche le vostre immagini, per personalizzare la camera.**

The Light door turns into Movie with screen printing of your favorite pictures. And the look of the room has no more limits. These are some of the textures we propose, but you can also screen print your images, to personalize the room.

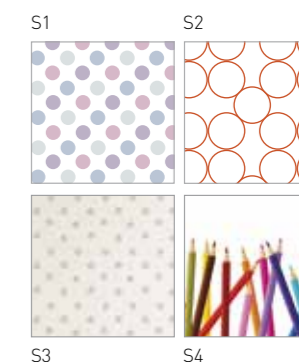

MANIGLIE E POMOLI

Handles and knobs

Le maniglie spaziano dalle forme essenziali a quelle decorative, dai colori alle diverse finiture per dare alle ante e ai frontali un tocco personale. Linee rette o curve, forme rotonde o quadrate per scelte tradizionali o creative, sempre a partire da una presa sicura e piacevole al tatto.

Handles ranges, from basic shapes to decorative from colors to different finishes to give the to door a personal touch. Straight or curved lines, round or square shapes for traditional or creative choices, always for a safe and pleasant grip.

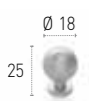

SFERA



Alluminio satinato
Brushed aluminum

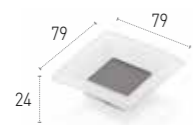

CUBE

Passo / Step 32 mm



Laccati opachi
Matt lacquered



FIORE



Laccati opachi
Matt lacquered



CLAP



Laccati opachi
Matt lacquered

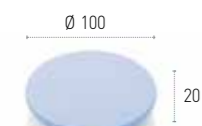

DISCO



Laccati opachi
Matt lacquered

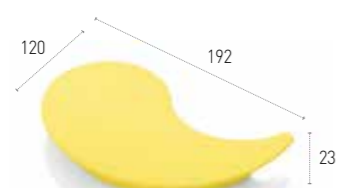

WAVE

Passo / Step 128 mm



Laccati opachi
Matt lacquered



ALLUMINIA

Passo / Step 160 mm
Passo / Step 896 mm



Bianco
White



Moka
Moka



Alluminio satinato
Brushed aluminum

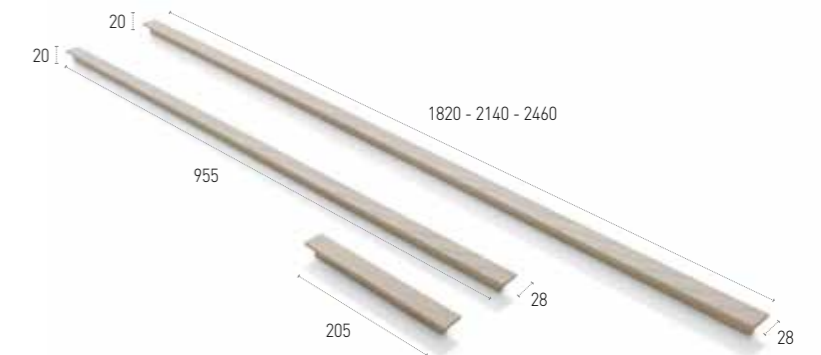

TASSELLO

Passo / Step 160 mm
Passo / Step 896 mm

OLMO



Bianco
White



Canapa
Canapa



Urbano
Urbano



Montego
Montego



Bianco
White



Laccati opachi
Matt lacquered

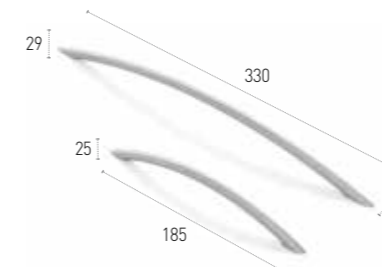

ARCHETTO

Passo / Step 160 mm
Passo / Step 288 mm



Bianco
White



Moka
Moka



Alluminio satinato
Brushed aluminum

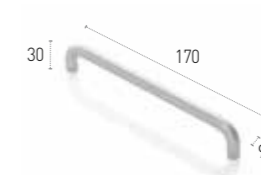

PONTE

Passo / Step 160 mm



Alluminio satinato
Brushed aluminum

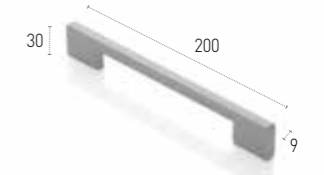

SATINATA

Passo / Step 160 mm



Laccati opachi
Matt lacquered

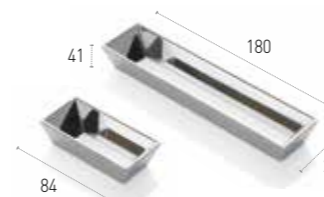

PIRAMIDE

Passo / Step 160 mm
Passo / Step 64 mm



Cromato
Chrome



Laccati opachi
Matt lacquered

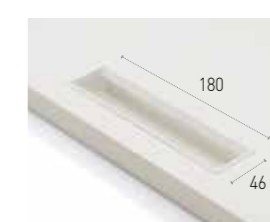

INCASSO



Bianco
White



Laccati opachi
Matt lacquered



PUSH-PULL



Alluminio satinato
Brushed aluminum



arreda con noi
la tua casa. furnish with us
your home.

SPAGNOLmobili SPAGNOLsalotti SPAGNOLcucine SPAGNOLcontract SPAGNOLmaterassi SPAGNOLleathersofa MOBILofficefurniture LAVALLEarredobagno VALPLANAcollezioni



SPAGNOLcucine

CUCINA

Un viaggio nelle forme della cucina, con gusto e funzionalità.

KITCHEN
A trip to the style of the kitchen, tastefully and functionality.



SPAGNOLmobili

LIVING

La versatilità e l'estetica dei sistemi a contenitore e a spalla portante.

LIVING
The versatility and aesthetics cabinets systems and side stand.



SPAGNOLsalotti SPAGNOLleathersofa

DIVANI

Il confort in oltre 200 varianti di colore di tessuto e morbida pelle.

SOFAS
The comfort in over 200 different colors of fabric and soft leather.



SPAGNOLmobili

CAMERE

Una grande scelta di armadi, cabine, letti e complementi per arredare liberamente.

BEDROOMS
A great choice of wardrobes, beds, and accessories to furnish freely.



SPAGNOLmobili

CAMERETTE

Infinite soluzioni di arredo moderne e contemporanee per bambini e ragazzi di tutte le età.

BEDROOMS
Unlimited solution of modern and contemporary furniture for children of any age.



MOBILofficefurniture

UFFICIO

L'arredo completo per l'ufficio e lo studio di casa.

OFFICE
The complete furnishings for the office and home office.



LAVALLEarredobagno

BAGNO

Stile, funzionalità, eleganza nei colori e nelle essenze naturali per vivere il tuo bagno nel massimo relax.

BATH
Style, functionality, elegance in the colors and natural woods to experience your bathroom in the maximum relax.



VALPLANAcollezioni

VALPLANA

Il profumo del legno nel rispetto della natura. Specializzata nella produzione di cucine, soggiorni, camere e bagni in stile country.

VALPLANA
The scent of wood in harmony with the nature. Specialized in the production of kitchens, living rooms, bedrooms and bathrooms in country style.

I NOSTRI VALORI

our values



SPAGNOLmobili

GARANZIA ESTENDIBILE A 10 ANNI

Spagnol Mobili offre la possibilità di estendere il periodo di garanzia sui propri prodotti da 2 a 10 anni dalla data di fabbricazione.

* Vedi condizioni specifiche nel certificato di garanzia.

EXTENDED WARRANTY ONLY FOR ITALY.

International Warranty: 2 Years



VERNICI ALL'ACQUA ANTIBATTERICHE CON SILVER DEFENCE

Vengono utilizzate vernici all'acqua monocomponente prive di solventi chimici nocivi. Inoltre, grazie agli additivi Silver Defence, la laccatura diventa barriera antimicrobica igienizzante.

COATINGS WITH SILVER ANTIBACTERIAL DEFENSE
We use one-component paints, with free-solvent in water-based without harmful chemicals. Moreover, thanks to additives Silver Defense, the lacquer becomes sanitizing antimicrobial barrier.



TUTTI I COLORI DEL MONDO

Oltre ai 48 laccati opachi e 29 laccati lucidi sono a disposizione 6 essenze e altre finiture nobilitate in diverse tonalità di colore per specifici modelli di anta.

ALL WORLD COLOURS
In addition to the 48 matt and 29 glossy lacquered colors there are 6 essences and other ennobled finture in different shades of color for specific models of door.



DESIGN E PRODUZIONE 100% MADE IN ITALY

Ogni prodotto è progettato e realizzato totalmente in Italia per assicurare un elevato standard qualitativo.

DESIGN AND PRODUCTION 100% MADE IN ITALY
Each product is designed and manufactured entirely in Italy to ensure a high quality standard.



RICICLABILITÀ DEGLI IMBALLI

Tutti gli imballi: polistirolo, cartone e termoretraibile sono riciclabili al 100%.

RECYCALBILITY OF PACKAGING
All packaging polystyrene, cardboard and shrink wrap are 100% recyclable.



PANNELLO ECOLOGICO

Il pannello truciolare ecologico realizzato al 100% con legno post-consumo, certificato fsc "100% recycled", e con le più basse emissioni di formaldeide al mondo. Un prodotto sicuro, concepito nel pieno rispetto della natura, sia dal punto di vista della produzione che da quello del consumo.

ECOLOGICAL PANEL
Ecological chipboard panel made in 100% post-consumer wood, certified fsc "100% recycled", and with the lowest formaldehyde emissions in the world. A safe product, conceived in full respect of the nature, both in the production and in the consumption.



STANDARD QUALITATIVI D'ECCELLENZA

Aderire ai più alti standard qualitativi internazionali, garantisce prodotti progettati secondo i migliori criteri di funzionalità, ergonomia e design, consegne sicure e rapide e montaggi efficienti.

QUALITY STANDARDS OF EXCELLENCE
Comply to the highest international quality standards, provides products designed with the highest criteria of functionality, ergonomics and design, safe delivery and quick and efficient assembly.



PROGRAMMA GRAFICO

Unico programma grafico per tutto il Gruppo Spagnol. Grazie a questo software, potrete presentare ai vostri clienti un preventivo preciso accompagnato da rendering.

GRAPHIC PROGRAM
Unique graphics program for the entire Spagnol Group. With this software, you can provide your customers an accurate economic offer accompanied by rendering.



SPAGNOL ON LINE

Il sito web è il punto di riferimento per tutte le informazioni e gli aggiornamenti sui prodotti.

www.spagnol.it

SPAGNOL ON LINE
The website is the reference point for all information and product updates.

Tutte le combinazioni di colori, materiali e finiture

All combinations of colors, materials and finishes

	Frontali SPAZIO	Frontali LIGHT (laccato opaco)	Frontali LACCATO OPACO poro aperto	Frontali LUX (laccato lucido)	Frontali METAL	Anta vetro telaio "0" chimico	Anta vetro telaio Brill	Top vetro sp. 1cm	Top e Mensole	Pedane	Strutture GLOBO	Strutture VEGA GIORNO	Strutture ARMADI SCORREVOLI	Boiserie Orizzontale	Boiserie Verticale	Boiserie Easy	Boiserie Max	Boiserie Fusion	Archimede	Letti	Strutture Comò e Comodini	Pannelli al mq e Scrittoi sp. 3,8 cm	Pannelli al mq sp. 1,8 cm	Sedie	Tavoli	Elementi e Basi universali	Pensili universali	Monoblocchi	
Nob. BIANCO	•							•	•	•	•	•	•	•	•	•	•	•	•	•	•	•	•	•	•	•	•	•	
Nob. MADREPERLA	•							•	•	•	•	•	•	•	•	•	•	•	•	•	•	•	•	•	•	•	•	•	•
Nob. OLMO BIANCO	•							•	•	•	•	•	•	•	•	•	•	•	•	•	•	•	•	•	•	•	•	•	•
Nob. OLMO CANAPA	•							•	•	•	•	•	•	•	•	•	•	•	•	•	•	•	•	•	•	•	•	•	•
Nob. OLMO MONTEGO	•							•	•	•	•	•	•	•	•	•	•	•	•	•	•	•	•	•	•	•	•	•	•
Nob. MANGO	•							•	•					•	•	•	•	•	•	•	•	•	•	•	•	•	•	•	•
Nob. MANDARINO	•							•	•					•	•	•	•	•	•	•	•	•	•	•	•	•	•	•	•
Nob. POMODORO	•							•	•					•	•	•	•	•	•	•	•	•	•	•	•	•	•	•	•
Nob. BAMBU	•							•	•					•	•	•	•	•	•	•	•	•	•	•	•	•	•	•	•
Nob. CARTA DA ZUCCHERO	•							•	•					•	•	•	•	•	•	•	•	•	•	•	•	•	•	•	•
Nob. NUVOLA	•													•	•	•	•	•	•	•	•	•	•	•	•	•	•	•	•
Nob. IRIS	•													•	•	•	•	•	•	•	•	•	•	•	•	•	•	•	•
Nob. GRIGIO	•													•	•	•	•	•	•	•	•	•	•	•	•	•	•	•	•
Nob. SABBIA	•													•	•	•	•	•	•	•	•	•	•	•	•	•	•	•	•
Nob. ROVERE BIANCO	•													•	•	•	•	•	•	•	•	•	•	•	•	•	•	•	•
Laccati OPACO	•							•	•	•	•	•	•	•	•	•	•	•	•	•	•	•	•	•	•	•	•	•	•
Laccati OPACO PORO APERTO		•																											
Laccati LUCIDO			•					•	•	•	•	•	•	•	•	•	•	•	•	•	•	•	•	•	•	•	•	•	•
Laccati METAL				•				•	•	•	•	•	•	•	•	•	•	•	•	•	•	•	•	•	•	•	•	•	•
Vetro ACIDATO						•	•																						
Vetro TRASPARENTE						•	•																						
Vetro BRONZO STOP SOL						•	•																						
Vetro LUCIDO LACCATO						•	•	•																					
Vetro SATINATO LACCATO						•	•																						
PLEXIGLASS						•	•																						

Questa tabella fornisce indicazioni generali sull'impiego di materiali, colori e finiture. Per una effettiva disponibilità consultare il listino prezzi.

This table provides general information concerning used materials, colors and finishes. For a specific availability have a look at the price list.

SPAGNOLmobili



Spagnol Mobili spa
Via Vidor, 1 - 31010 Mosnigo di Moriago (TV) - ITALY
Tel. +39.0438.89.11 - Fax +39.0438.89.00.82
www.spagnol.it - mobili@spagnol.it